

Universaldelar

Avgas



going the extra mile

www.dinex.net



HUZELLS
TUNGA DELAR

Innehåll

Symbol Identification.....	3
Dinex Group	4
Product Program	5

Clamps and Brackets

FlexFit & FlexJoiner Clamps	6
Circle & ButtFit Flat Clamps.....	7
PipeFit & TightFit Clamps	8
HoseFit, Heavy Duty & CT Band Clamps.....	9
Truck Make Clamps.....	10-11
U-Bolt Clamps.....	12
DIN Clamps.....	13
Hinged Clamps, Pipe Brackets & Pipe Clamps	14

V-Clamp Connection

V-Clamp Connection Kits (Truck Make Specific	15
Heavy Duty V-Clamps	16
V-Clamps Low Leakage	17
Exhaust Assembly Paste	17

Rubber Mountings

Rubber Mountings	18
------------------------	----

Pipe & Silencer Straps

Pipe & Silencer Straps	19
------------------------------	----

Heat Shields

Heat Shields	20
--------------------	----

Bends & Elbows

Bends OD/OD	21
Bends OD/ID	23-24
Elbows	25-26

Pipes & Adaptors

Straight Pipes	27
Extension Pipes	28
Tail Pipes	29
T & Y Adaptors, Connectors	30
Pipe Adaptors	31
Pipe Connectors	32
Insulation.....	32
Flex Pipes	33-36
Bellows	37

Rain Caps

Rain Caps	38
-----------------	----

Instruction

Flex pipe mounting instruction.....	39
Temperature Sensors	40
Euro 6 DPF Program	41
NOx Sensors.....	42-43

Symbol Identification

L	=	Length	ALU	=	Aluminised
W	=	Width	INOX	=	Stainless Steel
mm	=	Millimetre	ZINC	=	Zinc Coated
Inch	=	Inch	GALV	=	Galvanized
Ø	=	Diameter	SPD	=	Mild Steel
OD	=	Outside Diameter	OE	=	Original Equipment
ID	=	Inside Diameter	HP	=	Horse Power
CLR	=	Center Line Radius	BP	=	Back Pressure

Dinex Group

- going the extra mile

The Dinex Group is a leading global manufacturer and distributor of innovative engineered exhaust and emission control products and solutions for the heavy duty and gas engine industry.

Today, the Dinex Group, headquartered in Denmark, operates through 16 companies and employs approximately 1300 dedicated people worldwide.

The Dinex Group is present in 14 different countries with production and sales facilities in Denmark, UK, Finland, Germany, Latvia, USA, Turkey, Russia and China. Additionally, the Dinex Group has sales companies in Spain, Italy, France, Germany, UK, Poland and Serbia.

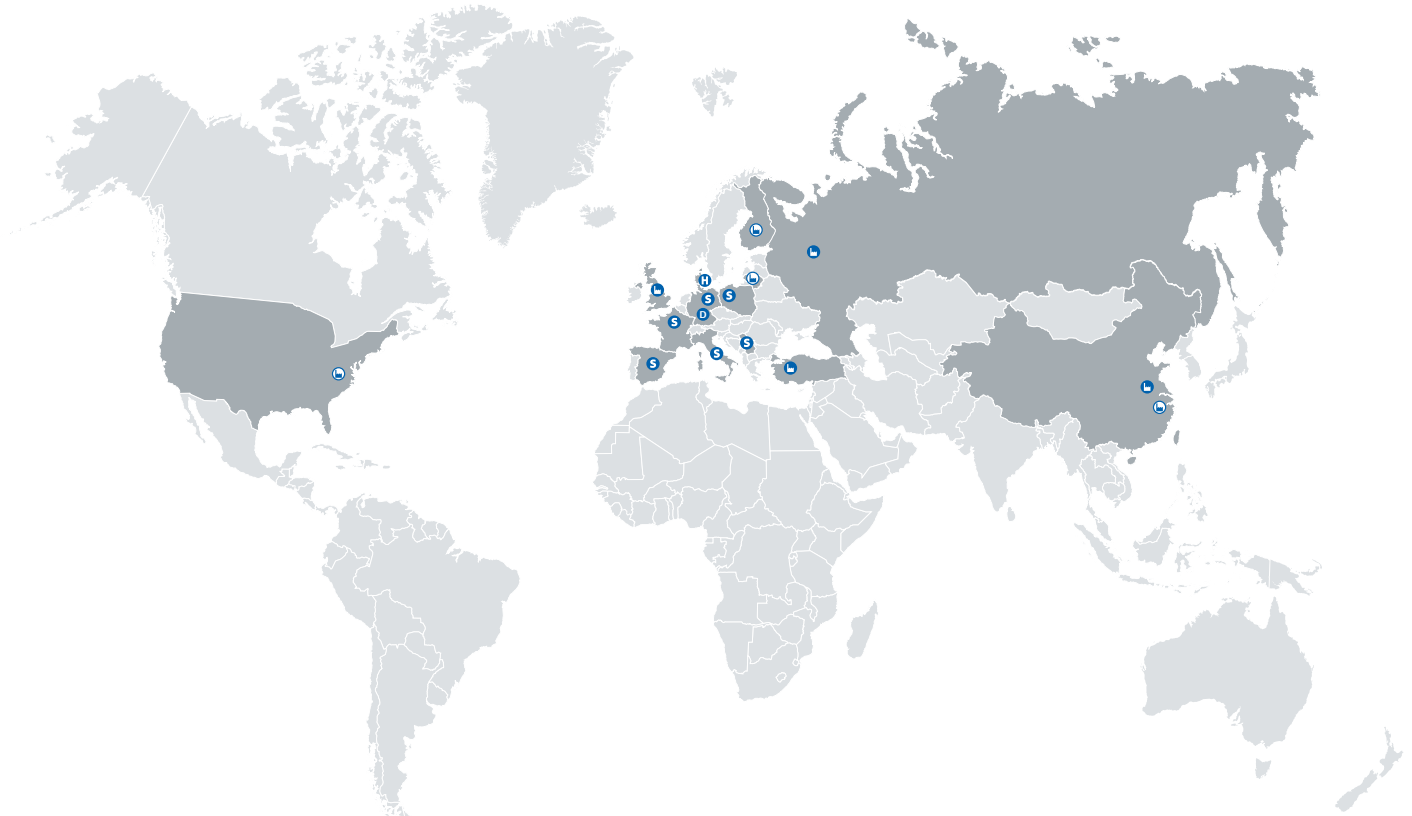

H Headquarter

L R&D, Production, Development & Sales

L Production, Development & Sales

S Sales

D Distribution center

H Dinex A/S, DK

L Dinex Ecocat Oy, FI

Dinex Latvia SIA, LV

Dinex Emission Inc., US

Dinex Emission System, CN

D Dinex Deutschland GmbH

L Dinex Clamps Ltd., GB

Dinex RUS LLC, RU

Dinex Egzoz ve Emisyon Tekn.sa, TR

JV - Hubei Dinex Tongda Emission

Solution Co. Ltd., CN

S Dinex Exhausts Ltd., GB

Dinex Polska Sp. Z.o.o., PL

Dinex GmbH, DE

Dinex Etma SAS, FR

Dinex Italia S.R.L., IT

Dinex Ibérica Sistemas de Esca, ES

Dinex Balkan D.O.O., RS

Dinex Deutschland GmbH, DE

Our vision is to...

... create value to our customers throughout the entire exhaust system lifecycle ...

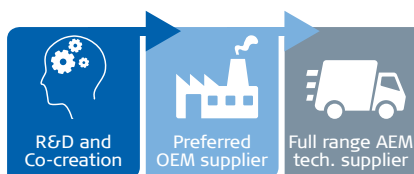

... through competitive edges ...

Edges
- Dinex offers

Forefront technology

In-house manufacturing capabilities

A complete product range

Reliable on-time delivery

... and core values.

Values
- Dinex strives to be

Flexible and agile

Close to customers





A trusted partner

An independent partner

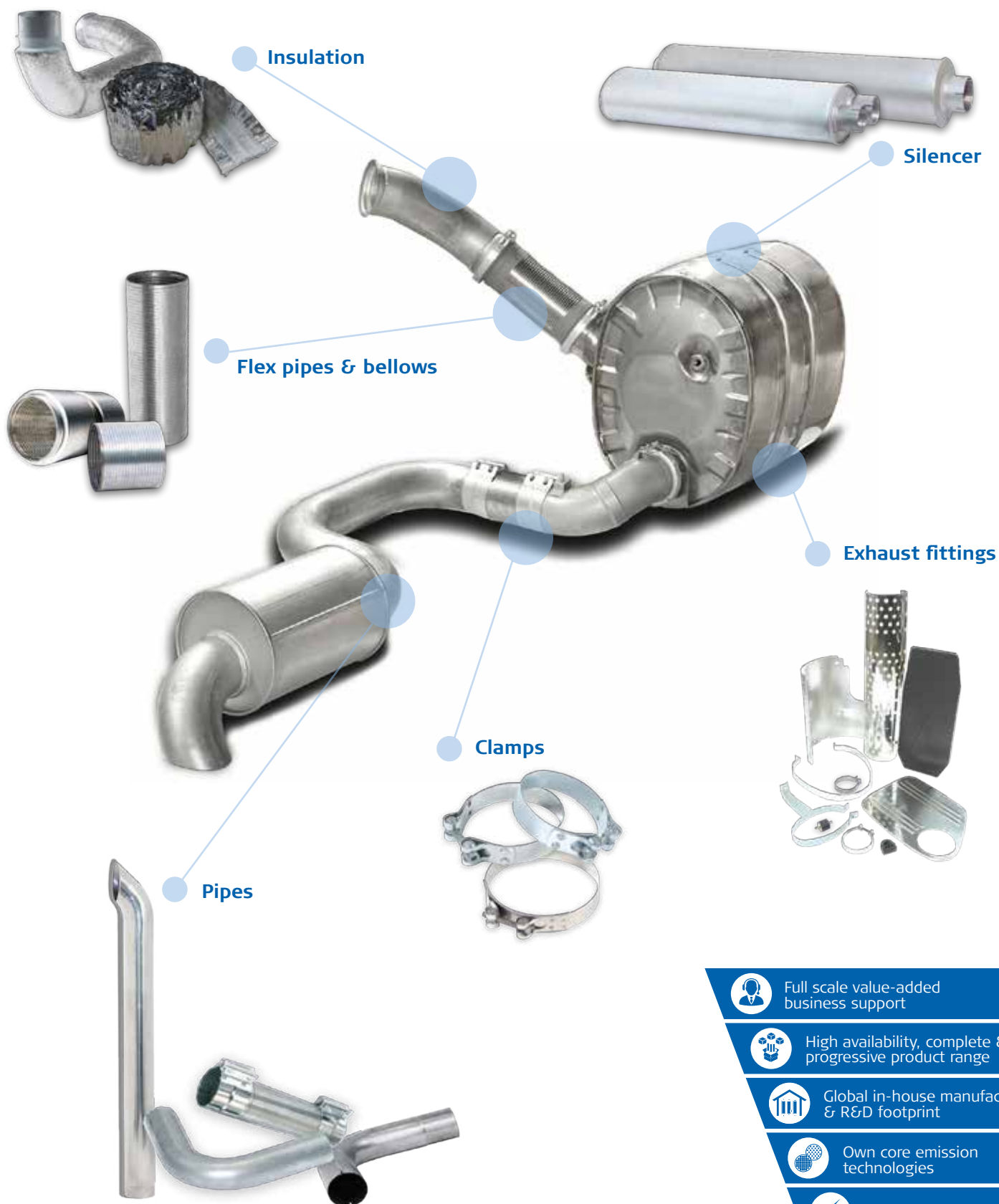
Broad Universal Product Program

- from turbo to tailpipe



-  Full scale value-added business support
-  High availability, complete & progressive product range
-  Global in-house manufacturing & R&D footprint
-  Own core emission technologies
-  High OE quality

FlexFit & FlexJoiner Clamps

FlexFit Clamps

Dinex no.		Ø flex		Ø pipe	
ALU	INOX	mm	Inch	mm	Inch
99250	99251	55,0	2 1/8	50,0	2
	99257	57,0	2 1/4	62,0	2 1/2
	99258	57,0	2 1/4	62,0	2 1/2
99260	99261	65,0	2 1/2	60,0	2 3/8
99264	99265	67,0	2 2/3	63,5	2 1/2
99270	99269	75,0	3	70,0	2 3/4
99276	99277	81,2	3 1/5	76,2	3
99280	99281	84,0	3 1/3	80,0	3 1/8
99289	99290	93,6	3 2/3	88,9	3 1/2
99300	99301	105,0	4 1/5	100,0	3 7/8
99302	99303	106,6	4 1/5	101,6	4
99308		113,0	4 1/2	108,0	4 1/4
99310	99311	115,0	4 1/2	110,0	4 1/3
80871	99315	119,0	4 3/4	114,3	4 1/2
99320	99321	125,0	5	120,0	4 3/4
99327	99328	132,0	5 1/5	127,0	5
99352	99350	158,0	6 1/5	152,0	6

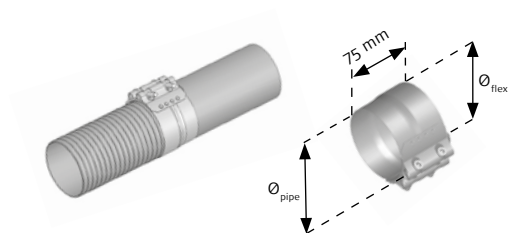

FlexFit Clamps

Dinex no.		Ø flex		Ø pipe	
ALU	INOX	mm	Inch	mm	Inch
	99316	119	4 3/4	114	4 1/2
99317		132	5 1/4	128	5

Material thickness 0,7 mm

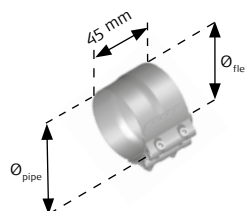

FlexJoiner Clamp

Dinex no.		Ø flex	
ALU	INOX	mm	Inch
99278	99279	77,1	3
99282	99283	81,0	3 1/8
99288	99291	88,9	3 1/2
99305	99306	102,7	4 3/8
99307	99309	110,0	4 1/3
99323	99324	115,5	4 1/2
99325	99326	121,1	4 3/4
99330	99331	132,0	5 1/16
99341	99342	157,5	6 1/5

Tightening torque 80 Nm.

Material thickness 0,7 mm



Circle & ButtFit Flat Clamps

Circle Clamps

Dinex no.	Ø mm	Ø Inch
ZINC		
99082	76,0 - 82,0	3
99094	83,0 - 94,0	3 1/2
99107	95,0 - 107,0	4
99114	108,0 - 114,0	4 1/4
99119	115,0 - 119,0	4 1/2
99132	120,0 - 132,0	5
99154	142,0 - 154,0	6

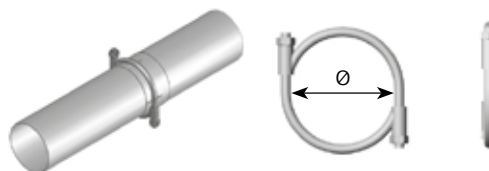

ButtFit Flat Clamps

Dinex no.	Dinex no.	Ø mm	Ø Inch
ALU		INOX	
99351	99451	50,8	2
99357	99457	57,0	2 1/4
99360		60,3	2 3/8
99363	99463	63,5	2 1/2
99370	99470	69,9	2 3/4
99376	99476	76,2	3
99389	99489	88,9	3 1/2
99402	99502	101,6	4
99408		108,0	4 1/4
99414	99514	114,3	4 1/2
99427	99527	127,0	5
99428		140,0	5 1/2
99455	99554	152,4	6

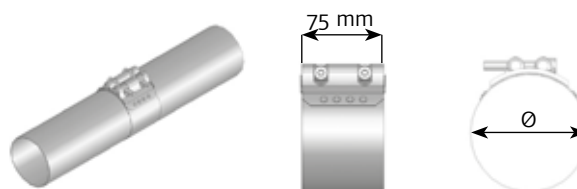

Tightening torque 80 Nm.
Material thickness 0,7 mm

PipeFit & TightFit Clamps

PipeFit Clamps

Dinex no.	Ø mm	Ø Inch	Clamp size range
INOX			Ø mm
99815	47,6	1 7/8	48 - 54
99800	50,8	2	51 - 57
99801	57,0	2 1/4	57 - 63
99816	60,3	2 3/8	60 - 66
99802	63,5	2 1/2	64 - 70
99817	66,7	2 5/8	67 - 73
99803	69,9	2 3/4	70 - 76
99804	76,2	3	76 - 82
99818	79,4	3 1/8	80 - 86
99805	85,0		85 - 91
99806	88,9	3 1/2	89 - 95
99819	100,0		100 - 106
99807	101,6	4	102 - 108
99808	110,0		110 - 116
99809	114,3	4 1/2	114 - 120
99810	120,0		120 - 126
99811	127,0	5	127 - 133
99812	139,7	5 1/2	140 - 146
99813	152,4	6	152 - 158

Tightening torque 60 Nm.
Material thickness 1.5 mm
Heavy Duty



TightFit Clamps

Dinex no.	Dinex no.	Ø mm	Ø Inch
ALU		INOX	
99851	99852	51,0 - 54,0	2
99858	99859	54,0 - 57,0	2 1/4
99860	99861	60,0 - 63,0	2 3/8
99864	99865	64,0 - 67,0	2 1/2
99866	99867	66,0 - 69,0	2 5/8
99871	99872	71,0 - 74,0	2 3/4
99877	99878	78,0 - 81,0	3
99880	99881	81,0 - 84,0	3 1/8
99885	99886	86,0 - 89,0	3 1/3
	99890	90,0 - 93,0	3 1/2
99892	99893	91,0 - 94,0	3 1/2
99900	99901	101,0 - 105,0	4
99903	99904	102,0 - 106,0	4
99910	99911	111,0 - 116,0	4 3/8
99915	99916	115,0 - 119,0	4 1/2
99920	99921	122,0 - 127,0	4 3/4
99928	99925	128,0 - 132,0	5
99953	99954	153,0 - 158,0	6
	99944	142,0 - 146,0	5 1/2
	99956	158,0 - 163,0	6 1/5

Tightening torque 30 Nm.
Material thickness 1.5 mm

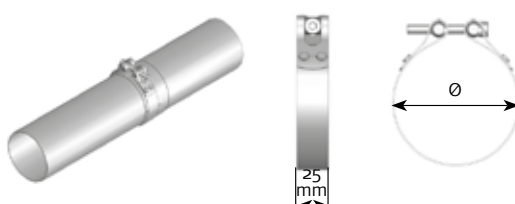

HoseFit, Heavy Duty & CT Band Clamps

HoseFit Clamps

Dinex no.	Ø mm	Ø Inch	A mm
INOX			
99150	50,0 - 55,0	2 - 2 1/5	20
99157	55,0 - 59,0	2 1/5 - 2 1/3	20
99160	59,0 - 63,0	2 1/3 - 2 1/2	20
99164	63,0 - 68,0	2 1/2 - 2 2/3	25
99176	79,0 - 85,0	3 - 3 1/3	25
99189	91,0 - 97,0	3 1/2 - 3 4/5	30
99202	104,0 - 112,0	4 - 4 2/5	25
99214	112,0 - 121,0	4 2/5 - 4 4/5	20
99227	121,0 - 133,0	4 4/5 - 5 1/5	30
99235	130,0 - 140,0	5 - 5 1/2	30

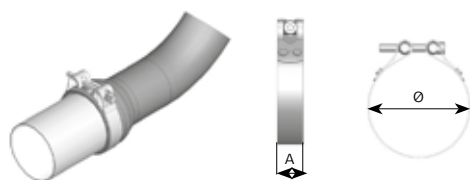

Heavy Duty Clamps

Dinex no	Ø mm	Ø Inch
ALU		
99548	45,5 - 48,5	1 4/5 - 1 9/10
99550	47,5 - 50,5	1 9/10 - 2
99553	50,5 - 53,5	2 - 2 1/10
99555	52,5 - 55,5	2 - 2 2/5
99558	55,5 - 58,5	2 2/5 - 2 1/3
99560	57,5 - 60,5	2 1/4 - 2 2/5
99563	60,5 - 63,5	2 2/5 - 2 1/2
99565	62,5 - 65,5	2 1/2 - 2 2/3
99568	65,5 - 68,5	2 2/3 - 2 7/10
99570	67,5 - 70,5	2 2/3 - 2 7/8
99573	71,5 - 73,5	2 4/5 - 2 9/10
99575	73,5 - 75,5	2 9/10 - 3
99578	75,5 - 78,5	3 - 3 1/9
99580	77,5 - 80,5	3 - 3 1/6
99585	82,5 - 85,5	3 1/4 - 3 2/5
99589	87,5 - 90,5	3 2/5 - 3 1/2
99594	91,5 - 94,5	3 5/8 - 3 5/7
99600	97,5 - 100,5	3 4/5 - 4
99604	101,5 - 104,5	4 - 4 1/8
99607	104,5 - 107,5	4 1/8 - 4 1/4
99610	107,5 - 110,5	4 1/4 - 4 1/3
99614	111,5 - 114,5	4 2/5 - 4 1/2
99620	117,5 - 120,5	4 5/8 - 4 6/8
99624	121,5 - 124,5	4 4/5 - 4 7/8
99627	124,5 - 127,5	4 7/8 - 5
99630	124,5 - 127,5	5 - 5 1/8
99633	130,5 - 133,5	5 1/8 - 5 1/4

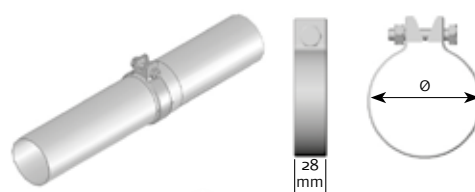

CT Band Clamps

Dinex no.	Ø mm	Ø Inch
INOX		
98870	32 - 54	1 1/4 - 2 1/8
98871	44 - 67	1 3/4 - 2 5/8
98872	57 - 79	1 1/4 - 3 1/8
98873	70 - 92	2 3/4 - 3 5/8
98874	83 - 105	3 1/4 - 4 1/8
98875	95 - 117	3 3/4 - 4 5/8
98876	108 - 130	4 1/4 - 5 1/8
98877	121 - 143	4 3/4 - 5 5/8
98878	133 - 156	5 1/4 - 6 1/8
98879	146 - 168	5 3/4 - 6 5/8
98880	159 - 181	6 1/4 - 7 1/8
98881	171 - 194	6 3/4 - 7 5/8
98882	184 - 206	7 1/4 - 8 1/8
98883	197 - 219	7 3/4 - 8 5/8
98884	210 - 232	8 1/4 - 9 1/8

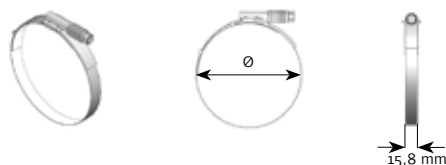

Truck Make Clamps

DAF U-Bolt Clamps M10

Dinex no	A mm	C mm	Ø mm	Ø Inch	OE
ZINC					
90172	120,0	40,0	72,0	2 3/4	
90084	130,0	40,0	84,0	3 1/4	682602
90192	140,0	40,0	92,0	3 5/8	
90096	145,0	40,0	96,0	3 3/4	682603
90098	150,0	40,0	98,0	3 3/4	682604
90105	195,0	40,0	105,0	4 1/8	682606
90109	160,0	40,0	109,0	4 1/4	682605
90120	170,0	40,0	120,0	4 3/4	682608
90130	185,0	60,0	130,0	5 1/8	682610
90142	195,0	40,0	142,0	5 5/8	682611
90155	205,0	40,0	155,0	6	682612
88887	220,0	80,0	155,0	6	
90165	220,0	55,0	165,0	6 1/2	

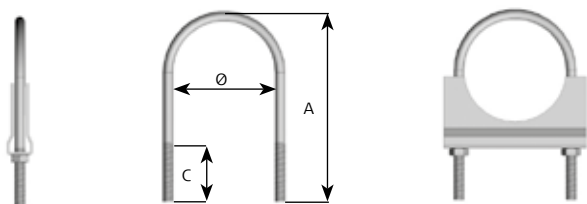

Scania Clamps

Dinex no.	Ø mm	Ø Inch	OE
ALU			
68818	114,0-119,0	4 1/2	328928
68819	119,0-124,0	5	1300367

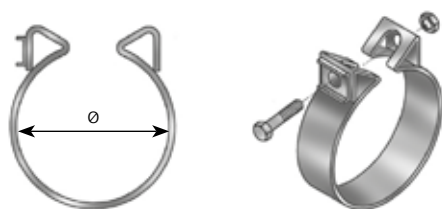

Truck Make Clamps

Volvo/Renault Clamps

Dinex no.	Dinex no.	Ø mm	Ø Inch	OE
ALU	INOX			
99042		39,0 - 42,0	1 5/8	
99045		42,0 - 45,0	1 3/4	
99048		45,0 - 48,0	1 7/8	
99051		48,0 - 51,0	2	
99055		52,0 - 55,0	2 1/8	975259
99058		55,0 - 58,0	2 1/4	975260
99061		58,0 - 61,0	2 3/8	
99064		61,0 - 64,0	2 1/2	
99067		65,0 - 67,0	2 5/8	
99071		68,0 - 71,0	2 3/4	
99074		71,0 - 74,0	2 7/8	
99077		74,0 - 77,0	3	
99083	99084	78,0 - 82,0	3 1/8	
99087	99088	83,0 - 87,0	3 1/4	
99096	99097	91,0 - 96,0	3 5/8	1193870
99100		100,0 - 106,0	3 7/8	
99108	99109	104,0 - 107,0	4	475499
99115	99116	108,0 - 114,0	4 1/2	
99120	99121	115,0 - 120,0	4 3/4	1589141
99127		123,0 - 128,0	5	
99135	99136	130,0 - 135,0	5 1/4	
99147		142,0 - 147,0	5 3/4	
99159		154,0 - 159,0	6	

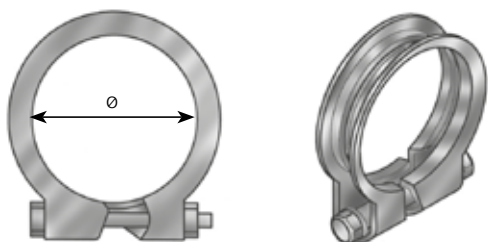

Mercedes/Iveco Clamps

Dinex no.	Ø mm	Ø Inch	OE	Design
ALU				
28810	59,5 - 62,5	2 3/8	8585923	A
28881	63,0 - 66,0	2 1/2	8591167	A
28811	65,0 - 68,0	2 1/2	8582510	A
28880	67,0 - 70,0	2 3/4	8567698	A
50926	74,0 - 77,0	3	6.734.920.140	A
50945	76,0 - 79,0	3	61597491	A
28853	80,0 - 83,0	3 1/8	4839513	A
50927	87,5 - 90,5	3 1/2	4819971	A
50924	92,0 - 96,0	3 3/4	6.744.920.040	A
28858	97,0 - 100,0	4	2483398	A
28873	102,0 - 105,0	4	42081440/42075778	B
28856	104,0 - 107,0	4	61605919	A
28874	106,0 - 110,0	4 3/8	2491711	B
28865	114,0 - 118,0	4 1/2	42075779/42090154	B
28866	118,0 - 122,0	4 3/4	42075780/42094001	B
28875	128,0 - 132,0	5	42092219	B
28876	131,0 - 135,0	5 1/4	42091873	B
28828	146,0 - 151,0	5 3/4	42094497	B

Design A

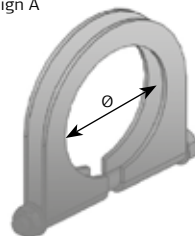

Design B



U-Bolt Clamps

U-Bolt Clamps - M8*

Dinex no.	Dinex no.	A mm	C mm	Ø mm	Ø Inch
ZINC	INOX				
90028		50,0	25,0	29,0	1 1/8
90032		60,0	23,0	32,0	1 1/4
90035		63,0	26,0	37,0	1 3/8
90038		65,0	26,0	38,0	1 1/2
90041		70,0	29,0	44,0	1 5/8
90045		75,0	25,0	45,0	1 3/4
90048		75,0	25,0	48,0	1 7/8
90052		80,0	25,0	52,0	2
90054		85,0	25,0	54,0	2 1/8
90057		85,0	40,0	57,0	2 1/4
90060		90,0	33,0	60,0	2 3/8
90061		100,0	43,0	60,0	2 3/8
90064		95,0	35,0	65,0	2 1/2
90067		95,0	22,0	67,0	2 5/8
90070		100,0	22,0	70,0	2 3/4
90073		100,0	22,0	73,0	2 7/8
90069		105,0	27,0	70,0	2 3/4
90076		105,0	25,0	76,2	3
90078		115,0	35,0	76,2	3
90079		120,0	25,0	80,0	3 1/8
90083		115,0	24,0	83,0	3 1/4
90089		125,0	25,0	88,9	3 1/2
	90119	150,0	30,0	89,0	
90131		140,0	40,0	89,0	3 1/2
90092		130,0	30,0	92,0	3 5/8
90095		135,0	40,0	95,3	3 3/4
90102	90107	135,0	30,0	102,0	4
90113		150,0	50,0	102,0	4
90106		140,0	35,0	105,0	4 1/8
	90108	155,0	40,0	114,3	4 5/8
90117		162,0	50,0	114,3	4 5/8
90114	90111	150,0	40,0	114,3	4 5/8
90127	90112	165,0	33,0	127,0	5
90129		177,0	48,0	130,0	5 1/8
	90139	184,0	62,0	139,7	5 1/2

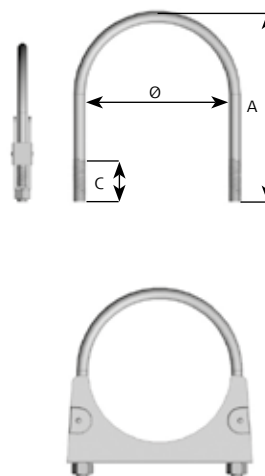

* Can be used for trailers (example - mud flaps)

DIN Clamps

DIN Clamps

Dinex no.	Dinex no.	Ø mm	Ø Inch	Mercedes OE	MAN OE
ALU	INOX				
99741		40,3	1 1/4		
99742		42,5	1 1/2		
99745		45,5	1 3/4	071.555.045.500	
99748		48,5	1 7/8	071.555.048.500	
99750		50,5	2	071.555.050.500	
99753		53,5	2 1/8	071.555.053.500	
99755		55,5		071.555.055.500	
99758		58,5	2 1/4	071.555.058.500	
99760		60,5	2 3/8	071.555.060.500	
99763		63,5	2 1/2	071.555.063.500	
99765		65,5		071.555.065.501	
99768		68,5	2 5/8	071.555.068.500	
99770		70,5	2 3/4	071.555.070.500	
99773		73,5	2 3/4	071.555.073.500	
99775		75,5		071.555.075.500	
99776	99777	76,5	3		
99778		78,5	3 1/8	071.555.078.502	
99780		80,5		071.555.080.502	
99785		85,5	3 3/8	071.555.085.502	06.67041.0121
99789	99790	90,5	3 1/2	071.555.090.501	06.67041.0123
99794		94,5	3 3/4		06.67041.0125
99700		100,5		071.555.100.500	06.67041.0124
99702		102,5	4		
99704	99703	104,5	4 1/8	071.555.104.501	81.97420.2017
99708		108,5	4 1/4		
99710	99711	110,5	4 3/8	071.555.110.501	81.97420.0073
99714	99715	114,5	4 1/2	81.97420.0085	
99720	99721	120,5	4 3/4	071.555.120.500	81.97420.0076
99724		124,5	4 7/8	071.555.124.500	
99727	99728	127,5	5		
99730		130,5	5 1/8	071.555.130.500	81.97401.0731

Material thickness 3-5 mm.

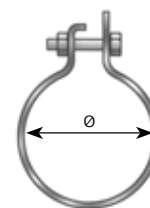

Hinged Clamps, Pipe Brackets & Pipe Clamps

Hinged Clamps

ZINC	Ø mm	Ø Inch
98753	53,5	2
98755	55,5	2 1/8
98758	58,5	2 1/4
98763	63,5	2 1/2
98765	65,5	2 5/8
98768	68,5	2 3/4
98770	70,5	2 7/8
98773	73,5	2 7/8
98775	75,5	3
98777	78,5	3 1/8
98780	80,5	3 1/8
98785	85,5	3 3/8
98790	90,5	3 1/2
98794	94,5	3 3/4
98700	100,5	3 7/8
98704	104,5	4 1/8
98710	110,5	4 3/8
98715	114,5	4 1/2
98720	120,5	4 3/4
98724	124,5	4 7/8
98730	130,5	5 1/8

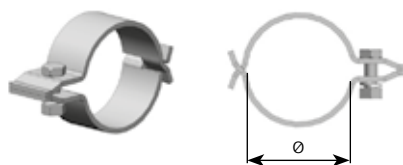

Pipe Clamps

Dinex no	Ø mm	Ø Inch
ZINC		
99460	60	2 3/8
99475	75	3
99480	80	3 1/8
99490	90	3 1/2
99410	110	4 3/8
99420	120	4 3/4



Pipe Brackets

Dinex no.	Ø mm	Ø Inch	C mm	C Inch	L mm	Design
ZINC						
90151	50,0	2	11	1/2	85,0	A
90161	60,0	2 3/8	11	1/2	90,0	A
90171	70,0	2 3/4	11	1/2	100,0	A
90175	75,0	3	11	1/2	105,0	A
90181	80,0	3 1/8	11	1/2	122,0	A
90191	90,0	3 1/2	11	1/2	115,0	B
90104	100,0	3 7/8	11	1/2	120,0	B
90110	110,0	4 3/8	11	1/2	150,0	A
90116	115,0	4 1/2	11	1/2	155,0	A
90121	120,0	4 3/4	11	1/2	160,0	B

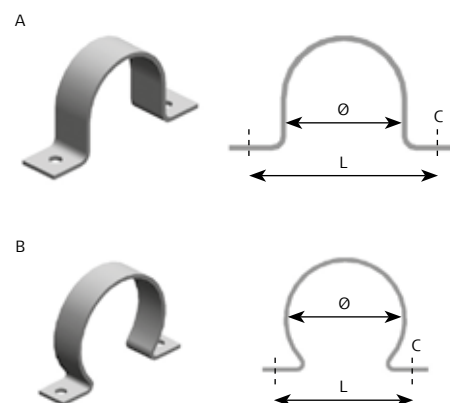

Material thickness 4 mm

V-Clamp Connection Kits (Truck Make Specific)

DAF

Dinex no.	Dinex no.	Dinex no.	Dinex no.	Dinex no.	Dinex no.	Ø mm	Ø Inch
Male	Male	Clamp	Clamp	Female	Female		
ALU	INOX	ALU	INOX	ALU	INOX		
78201		21817		78217	78241	101,6	4
78215	78225	21821		78216		114,3	4 1/2
78229	78240		21850	78230	78233	127,0	5

Mercedes

Dinex no.	Dinex no.	Dinex no.	Dinex no.	Dinex no.	Dinex no.	Ø mm	Ø Inch
Male	Male	Clamp	Clamp	Female	Female		
ALU	INOX	ALU	INOX	ALU	INOX		
78150		50829	50971	78151		50,0	2
78175	78220	50810	50972	50218		75,0	3
78189		50852	50973	51170		85,0	3 3/8
78200		50849	50974	51126		95,0	3 7/8

Volvo

Dinex no.	Dinex no.	Dinex no.	Dinex no.	Dinex no.	Dinex no.	Ø mm	Ø Inch
Male	Male	Clamp	Clamp	Female	Female		
ALU	INOX	ALU	INOX	ALU	INOX		
78190		80905	78890	78191	78235	88,9	3 1/2
			80806	78192		88,9	3 1/2
78202	78223	80910	78803	78203	78222	101,6	4
78214	78224	80848	78815	78218	78236	114,3	4 1/2
78227	78244	80921	78828	78228	78232	127,0	5

Other Clamps

Dinex no.	Dinex no.	Ø mm	Ø Inch	Design
ZINC	INOX			
21817		110,0	4 1/2	3
21821	21850	127,0	5	3
50810	50972	76,0	3	1
50829	50971	50,0	2	1
50849	50974	102,0	4	1
50852	50973	88,9	3 1/2	1
80848		114,0	4 1/2	2
80905		88,4	3 1/2	3
80910		101,6	4	3
81921		127,0	5	4

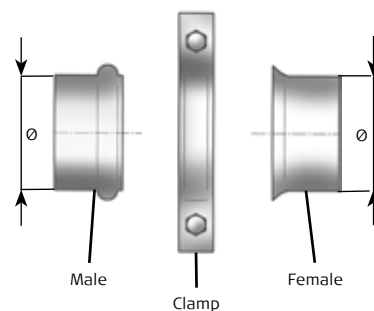

Scania

Dinex no.	Dinex no.	Dinex no.	Ø mm	Ø Inch
Male	Clamp	Female		
ALU	ALU	ALU		
78256	68835	78257	114,3	4 1/2
78269	68858	78268	127,0	5



Heavy Duty V-Clamps

Dinex no.	Dinex no.	A mm	mm	Inch	B°	C mm	D mm	E mm	Bolt
ALU	INOX	Clamp Ø	Pipe Ø	Pipe Ø	Ve e Angle	Ve e Depth	Ve e Tip	Strap	Size
	51958	73	54,0	2	40°	4	6,6	20	M6
	66804	73	54,0	2	76°	8	R 2,5	none	M6
	68896	80	63,5	2 1/2	40°	5,8	6,75	20	M6
	74809	80	63,5	2 1/2	40°	7	8	20	M6
	88861	82	63,5	2 1/2	40°	4	6	20	M6
73809		84	63,5	2 1/2	76°	8	R 2,5	none	M6
	47820	97	76,1	3	40°	4,4	10	20	M6
	68897	97	76,1	3	40°	5	8	20	M6
	18921	99	76,1	3	40°	7	5	20	M6
	44805	102	76,1	3	40°	7	10	20	M6
	68899	102	88,9	3 1/2	40°	6	6,3	20	M6
	78801	105	88,9	3 1/2	40°	4	6	20	M6
	70819	108	88,9	3 1/2	40°	7	5	20	M6
	78890	113	88,9	3 1/2	40°	7	10	20	M6
	21895	116	88,9	3 1/2	40°	7,1	6,8	20	M6
	80807	119	88,9	3 1/2	84°	9,6	8,1	25	M8
	68898	120	101,6	4	40°	7,3	6,6	25	M8
	70804	121	101,6	4	40°	7	10	20	M6
	44937	122	101,6	4	40°	7	5,26	20	M6
	41833	124	101,6	4	40°	4	6,65	20	M6
80910	78803	125	101,6	4	40°	7	11	20	M6
	21896	129	114,3	4 1/2	40°	7	10,16	25	M8
	68835	132	114,3	4 1/2	40°	6	6	25	M8
68867		132	114,3	4 1/2	40°	6	6	none	M8
	80806	135	114,3	4 1/2	86°	9,5	8,1	25	M8
	78815	137	114,3	4 1/2	40°	7	11	20	M6
29806		138	114,3	4 1/2	40°	7	9	20	M6
	49939	142	114,3	4 1/2	40°	8	9,2	25	M8
	51964	145	127,0	5	40°	6	6,6	25	M8
	68858	146	127,0	5	40°	6	6	20	M6
	78828	151	127,0	5	40°	7	10	25	M8
	80918	151	127,0	5	40°	7	10	25	M8
80921		151	127,0	5	40°	7	10	20	M6
81921		151	127,0	5	40°	7	10	none	M6
	21850	151	127,0	5	40°	7	7	20	M6
	99128	155	127,0	5	40°	7	5,26	20	M6
	28905	159	127,0	5	40°	9,5	8,8	25	M8
	86810	175	152,2	6	40°	7	6,5	20	M6
	43958	186	152,2	6	40°	7	3,2	20	M6

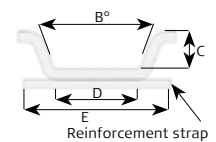
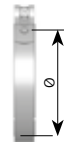
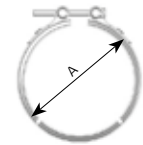

Reinforcement strap

V-Clamps Low Leakage (for Euro IV to VI Applications)

Single Bolt (For Applications < 550° C)

Dinex no.	Dinex no.	L1	Dinex no.	Dinex no.	L2	Ø	Ø
Clamp*	Male**	mm	Gasket	Female**	mm	mm	Inch
99679	532511	100	78844	532510	100	76,1	3
99680	532515	61	78845	532514	100	88,9	3 1/2
99681	532517	100	78846	532516	100	101,6	4
99682	532521	100	78847	532520	100	114,3	4 1/2
99683	532523	55	78848	532522	100	127,0	5

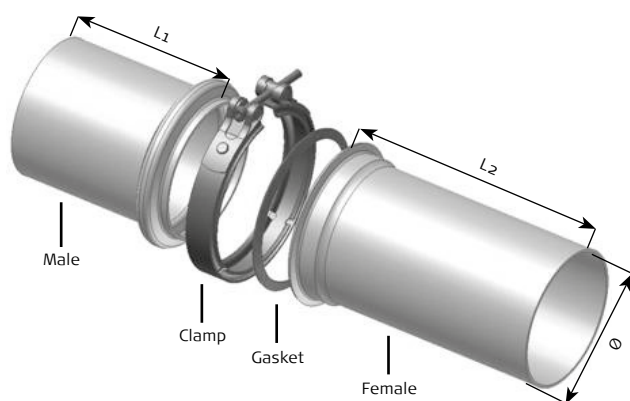

Double Bolt (For Applications < 1000° C)

Dinex no.	Dinex no.	L1	Dinex no.	Dinex no.	L2	Ø	Ø
Clamp*	Male**	mm	Gasket	Female**	mm	mm	Inch
99684	532511	100	78839	532510	100	76,1	3
99685	532515	61	78840	532514	100	88,9	3 1/2
99686	532517	100	78841	532516	100	101,6	4
99687	532521	100	78842	532520	100	114,3	4 1/2
99688	532523	55	78843	532522	100	127,0	5

*Max tightening torque 40 Nm - two 8 mm bolts

** Material: Stainless steel grade EN 1.4303

Exhaust Assembly Paste

Dinex no	ml
78800	500

Withstand temperatures up to 1000 °C.



Rubber Mountings

M8

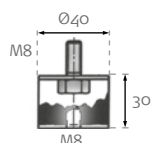

49907
81.96210.052

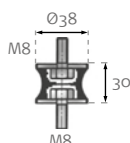

21822
0285530
651183

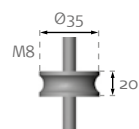

50907
322.504.0212

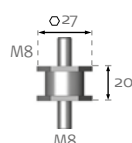

51941
001.987.5240

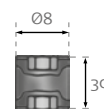

28837
98415197

M10

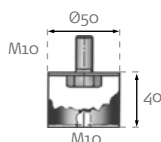

49838
81.96210.0101

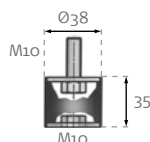

50950
697.987.0139

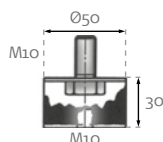

49910
81.96210.0153

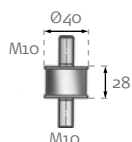

64804
5000750531

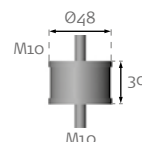

44800
0487257

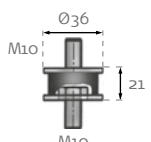

50910
001.987.5340

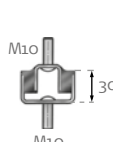

69804
4.771.333.000

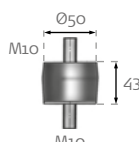

80949
324842

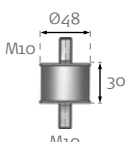

64817
5000750630

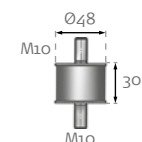

69817
4.771.244.000

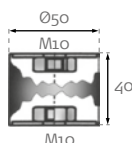

80951
1580440

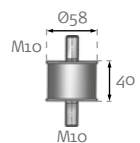

70807
36233 51

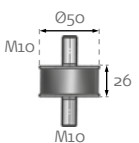

24903
104939-8

M12

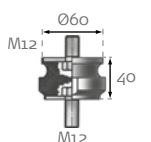

21820
0221342

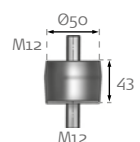

80950
6 850149

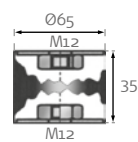

68900
40607

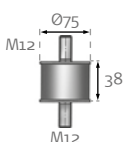

92975
4.771.308.000

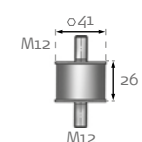

21905
1405183

Universal

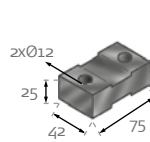

50912
667.490.0037

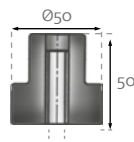

24902
100348-3

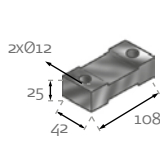

50904
309.490.0037



50984
202.492.0344

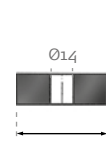

64801
0000689778

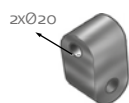

24904
117280-3

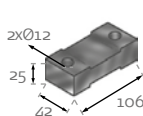

21828
0298390

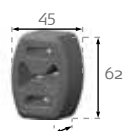

28901
93818454

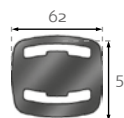

50809
381.492.0082



50985
901.492.0044

Pipe & Silencer Straps

Dinex no	Ø mm	Ø Inch
ALU		
98060	60,0	2 3/8
98076	76,2	3
98089	88,9	3 1/2
98102	101,6	4
98108	108,5	4 1/4
98114	114,3	4 1/2
98127	127,0	5
98155	155,0	6
98184	184,0	7
98206	206,0	8
98249	249,0	10
98260	260,0	10 1/4
98284	284,0	11
98300	300,0	11 3/4
98320	320,0	12

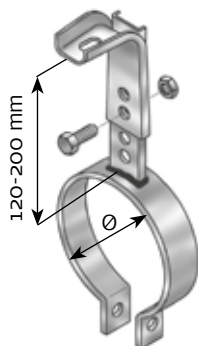

Dinex no	Ø mm	Ø Inch
ALU		
49815	180x280	7 x 10 3/4
88805	202x302	8 x 11 7/8
49841	180x280	7 x 10 3/4
70816	254x381	10 x 15
50860	180x280	7 x 10 3/4
49801	250x300	9 7/8 x 11 7/8
49833	305x505	12 x 19 7/8
21819	254x380	10 x 15



Dinex no	Ø mm	Ø Inch
ALU		
98752	155,0	6
98778	178,0	7
98784	184,0	7 1/4
98703	206,0	8
98728	228,0	9
98754	254,0	10
98779	284,0	11
98805	300,0	12
28800	380,0	15

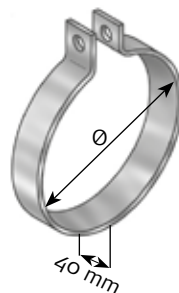

Adjustable Silencer Strap

Dinex no
ALU
95505

Material thickness 3 mm.

For body straps for specific vertical systems, please see separate sections of the catalogue (page 53-54).

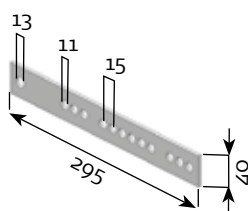

Dinex no	Ø mm	Ø Inch
ALU		
98061	65	2 1/2
98062	65	2 1/2

Material thickness 3 mm.



Heat Shields

Dinex no.	L mm	Dinex no.	ID mm	Dinex no.
INOX		B (x2)		C
95506	1000	95876	76,2	95801
95520	1000	95889	88,9	95801
95532	1000	95802	101,6	95801
95545	1000	95814	114,3	95801
95627	1000	95827	127,0	95801
95614	1000	95884	184,0	95801
95636	1000	95906	206,0	95801
95680	1000	95950	250,0	95801
95717	1250	95448	265,0	95801
95714	1000	95984	284,0	95801
68814	900	68813	300,0	
95716	1300	95426	300,0	95801

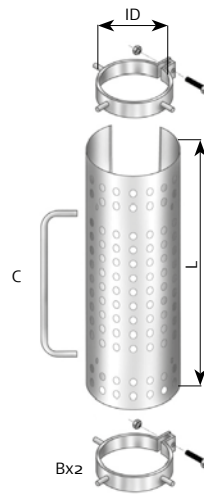

Dinex no.	L mm	Ø mm	L1 mm
ZINC			
95550	800	50	100
95560	800	60	100
95570	800	70	100
95575	800	75	100
95589	800	90	140
95510	800	110	140
95514	800	114	140
95521	800	120	140
95503	800	160	140

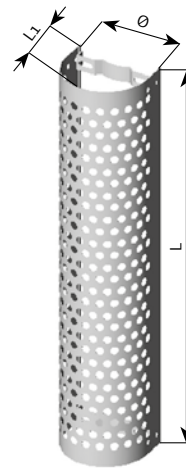

Ø - pipe diameter
Brackets are included

Bends OD/OD

90° (OD/OD)

Dinex no.	Dinex no.	L mm	OD mm	OD Inch	CLR
ALU	INOX				
91039		129	38,0	1 1/2	54,0
91046		180	45,0	1 3/4	64,0
91050		190	50,0	2	95,0
	91250	190	50,8	2	95,0
91056		240	57,0	2 1/4	85,0
91059	91259	240	60,0	2 3/8	100,0
	91264	190	63,5	2 1/2	85,0
91063		265	63,5	2 1/2	85,0
91065		265	65,0	2 5/8	91,0
91071		270	70,0	2 3/4	98,0
91073		290	75,0	3	135,0
91075	91275	295	76,2	3	99,1
91080		290	80,0	3 1/8	115,0
91088	91288	320	88,9	3 1/2	135,0
91091		320	88,9	3 1/2	177,0
91100		380	100,0	3 7/8	203,0
91101	91201	380	101,6	4	150,0
91106	91107	254	101,6	4	150,0
91109		400	110,0	4 3/8	148,0
91111		450	110,0	4 3/8	148,0
91113		390	114,3	4 1/2	161,0
	91213	400	114,3	4 1/2	161,0
91120		410	120,0	4 3/4	170,0
91125		330	127,0	5	173,0
91127	91228	415	127,0	5	173,0
91153		475	152,4	6	225,0

Material thickness ranging from 1,5 to 2,0 mm.

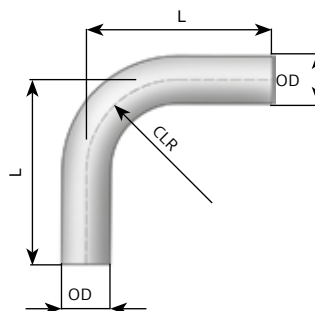

Bends OD/OD

60° (OD/OD)

Dinex no.	L mm	OD mm	OD Inch	CLR
ALU				
92438	90	38,0	1 1/2	54,0
92442	100	42,0	1 5/8	95,0
92448	155	48,0	2	95,0
92450	155	50,0	2	95,0
92460	165	60,0	2 3/8	100,0
92465	205	65,0	2 5/8	91,0
92470	180	70,0	2 3/4	135,0
92475	190	75,0	3	135,0
92476	180	76,2	3	99,1
92480	250	80,0	3 1/4	115,0
92489	205	88,9	3 1/2	135,0
92490	210	90,0	3 5/8	177,0
92500	250	100,0	4	150,0
92510	360	110,0	4 3/8	148,0
92515	310	114,3	4 1/2	161,0
92520	380	120,0	4 3/4	173,0
92526	320	127,0	5	173,0

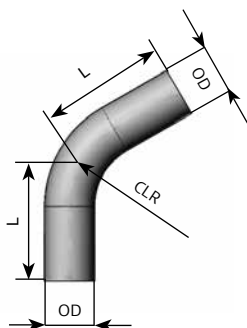

45° (OD/OD)

Dinex no.	Dinex no.	L mm	OD mm	OD Inch	CLR
ALU					
INOX					
92039		112,0	38,0	1 1/2	54,0
92040		140,0	38,0	1 1/2	54,0
92046		142,5	45,0	1 3/4	64,0
92050		140,0	50,0	2	95,0
92056		150,0	57,0	2 1/4	85,0
92059		150,0	60,0	2 3/8	100,0
92063		180,0	63,5	2 1/2	85,0
92061	92263	140,0	63,5	2 1/2	85,0
92062		180,0	63,5	2 1/2	85,0
92065		180,0	65,0	2 5/8	91,0
92071		205,0	70,0	2 3/4	98,0
92075		230,0	76,2	3	99,1
92080		230,0	80,0	3 1/8	115,0
92088		225,0	88,9	3 1/2	177,0
92100		245,0	100,0	3 7/8	203,0
92101		245,0	101,6	4	203,0
92104		235,0	101,6	4	150,0
92109		260,0	110,0	4 3/8	148,0
92113		260,0	114,3	4 1/2	161,0
92120		365,0	120,0	4 3/4	170,0
92127		365,0	127,0	5	173,0
92129		305,0	127,0	5	173,0
92153		338,0	152,4	6	225,0

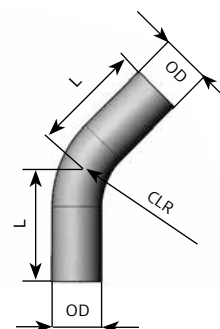

Material thickness ranging from 1,5 to 2,0 mm.

Bends OD/ID

90° (OD/ID)

Dinex no.	Dinex no.	L mm	ID mm	OD mm	OD Inch	CLR
ALU	INOX					
91038		129	39,0	38,0	1 1/2	54,0
91045		180	46,0	45,0	1 3/4	64,0
91051	91552	195	51,5	50,0	2	95,0
	91550	195	51,3	51,0	2	95,0
91057		240	57,6	57,0	2 1/4	85,0
91060	91560	240	60,5	60,0	2 3/8	100,0
	91563	190	64,0	63,5	2 1/2	85,0
91064		265	64,0	63,5	2 1/2	85,0
91066		265	65,3	65,0	2 5/8	91,0
91070		270	70,3	70,0	2 3/4	98,0
91074		290	75,5	75,0	3	135,0
91076		290	76,5	76,1	3	99,1
	91576	295	76,7	76,1	3	135,0
91089	91589	320	89,4	88,9	3 1/2	177,0
91102		380	102,1	101,6	4	150,0
	91502	380	102,1	101,6	4	150,0
91103		200	102,1	101,6	4	150,0
91105		254	102,1	101,6	4	150,0
91108		400	108,5	108,0	4 1/4	148,0
91110		400	110,5	110,0	4 3/8	148,0
91114	91514	390	114,8	114,3	4 1/2	161,0
91121		410	121,0	120,0	4 3/4	170,0
91128	91527	415	128,0	127,0	5	173,0
91129		330	128,0	127,0	5	173,0
91152		475	153,5	152,4	5	225,0

Material thickness ranging from 1,5 to 2,0 mm.

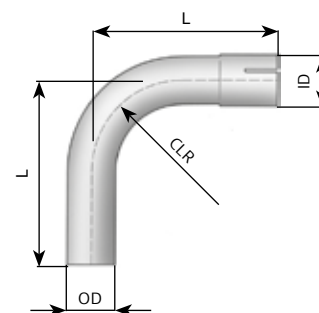

Bends OD/ID

60° (OD/ID)

Dinex no.	L mm	ID mm	OD mm	OD Inch	CLR
ALU					
92338	100,0	38,3	38,0	1 1/2	100
92348	90,0	48,3	48,0	2	95
92350	80,0	50,3	50,0	2	95
92360	165,0	60,3	60,0	2 3/8	100
92365	210,0	65,3	65,0	2 5/8	91
92370	200,0	70,3	70,0	2 3/4	135
92375	250,0	75,3	75,0	3	135
92380	250,0	80,3	80,0	3 1/4	115
92389	202,4	89,2	88,9	3 1/2	177
92390	200,0	90,3	90,0	3 5/8	177
92400	254,0	100,3	100,0	4	150
92410	210,0	110,3	110,0	4 3/8	260
92414	240,0	114,6	114,3	4 1/2	161
92420	400,0	120,3	120,0	4 3/4	161
92427	140,0	127,3	127,0	5	173

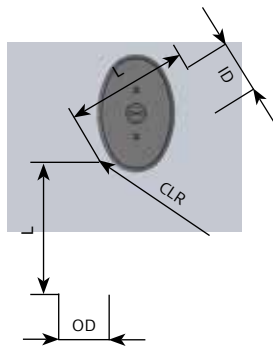

45° (OD/ID)

Dinex no.	Dinex no.	L mm	ID mm	OD mm	OD Inch	CLR
ALU						
92038		112,0	39,0	38,0	1 1/2	54,0
92045		142,5	46,0	45,0	1 3/4	64,0
92051		140,0	51,3	50,0	2	95,0
	92551	180,0	51,5	50,8	2	95,0
92057		150,0	57,6	57,0	2 1/4	85,0
	92560	150,0	60,5	60,0	2	100,0
92060		150,0	60,5	60,0	2 3/8	100,0
	92563	180,0	64,0	63,5	2 1/2	85,0
92064		180,0	64,0	63,5	2 1/2	85,0
92066		180,0	65,5	65,0	2 5/8	91,0
92070		205,0	70,3	70,0	2 3/4	98,0
92074		230,0	75,5	75,0	3	135,0
92076	92576	205,0	76,7	76,1	3	99,1
92089	92589	225,0	89,4	88,9	3 1/2	177,0
92102	92502	245,0	102,1	101,6	4	203,0
92103		235,0	102,1	101,6	4	150,0
92108		260,0	108,5	108,0	4 1/4	148,0
92110		260,0	110,5	110,0	4 3/8	148,0
92114	92514	260,0	114,8	114,3	4 1/2	161,0
92121		365,0	121,0	120,0	4 3/4	170,0
92126		305,0	128,0	127,0	5	173,0
92128	92528	365,0	128,0	127,0	5	173,0
	92527	375,0	128,0	127,0	5	173,0
92152		338,0	153,5	152,4	6	225,0

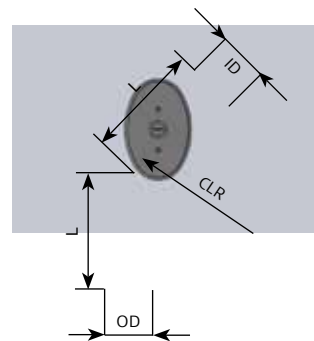

Material thickness ranging from 1,5 to 2,0 mm.

Elbows

OD/OD

Dinex no.	L mm	Dinex no.	L mm	OD mm	OD Inch
SPD		INOX			
96050	200			50,0	2
96064	200			63,5	2 1/2
96075	194	96375	200	76,2	3
96088	180	96388	201	88,9	3 1/2
96101	200	96401	236	101,6	4
91104	152			101,6	4
96107	190			108,0	4 1/4
96113	200		200	114,3	4 1/2
		96412	254	114,3	4 1/2
96126	223	96426	266	127,0	5

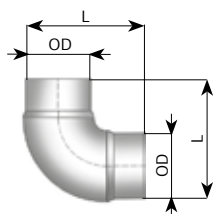

OD/OD (Cast)

Dinex no.	Dinex no.	OD mm	Inch	T mm	CLR
SPD		INOX			
96260		60,0	2 3/8	2,9	76
96270		70,0	2 3/4	2,9	92
	96277	76,1	3	2,0	95
96276		76,1	3	2,9	95
	96290	88,9	3 1/2	2,0	114
96289		88,9	3 1/2	3,2	115
96202		101,6	4	3,6	134
	96204	104,0	4	2,0	150
96208		108,0	4 1/4	3,6	143
	96215	114,8	4 1/2	2,0	152
96214		114,3	4 1/2	3,6	153
	96230	129,0	5 1/8	2,0	188
96229		133,0	5 1/4	4,0	188

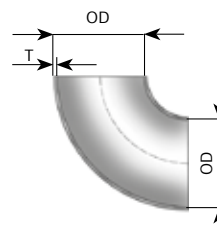

OD/OD (Welded/Thin Wall)

Dinex no.	Dinex no.	OD mm	Inch	T mm	CLR
SPD		INOX			
96046	96246	50,8	2	1,5	50,8
96063		63,5	2 1/2	1,5	50,8
	96263	63,5	2 1/2	1,5	63,0
	96274	76,2	3	1,5	63,5
96074	96278	76,2	3	1,5	76,2
	96287	88,9	3 1/2	1,5	76,0
96087	96288	88,9	3 1/2	1,5	88,9
	96300	101,6	4	1,5	85,0
96100	96301	101,6	4	1,5	101,6
96106		108,0	4 1/4	1,5	76,0
	96312	114,3	4 1/2	1,5	96,8
96112		114,3	4 1/2	1,5	114,3
	96325	127,0	5	1,5	100,0
96109		127,0	5	1,5	127,0
96125		130,0	5 1/8	1,5	100,0

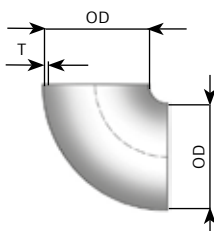

Material thickness ranging from 1,5 to 2,0 mm.

Elbows

OD/ID

Dinex no.	Dinex no.	L1 mm	L2 mm	OD mm	ID mm	OD Inch
SPD	INOX					
96051		200	200	50,0	51,3	2
96065		200	200	63,5	64,0	2 1/2
96076	96376	200	200	76,1	77,0	3
96089		200	210	89,0	89,5	3 1/2
	96389	201	203	88,9	91,0	3 1/2
96102		200	210	101,6	102,5	4
	96402	243	243	101,6	102,1	4
96108		200	210	108,0	108,5	4 1/4
96110		200	210	110,0	111,0	4 1/3
96114	96414	207	207	114,3	114,5	4 1/2
91126		255	255	127,0	128,0	5
96127		225	223	127,0	128,0	5
	96427	265	265	127,0	128,0	5

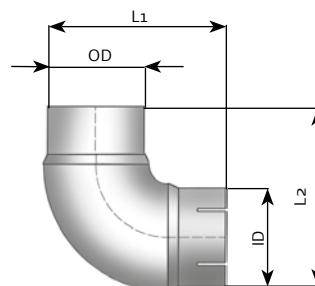

ID/ID

Dinex no.	Dinex no.	L1 mm	L2 mm	ID mm	ID Inch
SPD	INOX				
97051		200	200	51,3	2
97065	96373	200	200	64,0	2 1/2
97076		200	200	77,0	3
	96377	200	200	76,8	3
97089		200	200	89,5	3 1/2
	96390	200	200	89,5	3 1/2
97102		200	210	102,5	4
	96403	243	243	102,1	4
97110		220	210	110,5	4 3/8
97108		200	210	108,5	4 1/4
97114		207	207	114,5	4 1/2
	96415	254	254	114,8	4 1/2
97127		225	225	128,0	5

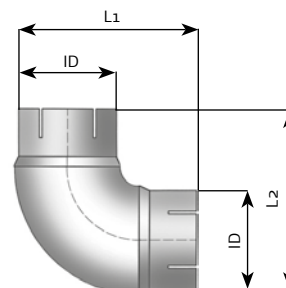

Material thickness ranging from 1,5 to 2,0 mm.

Straight Pipes

ALU

Dinex no.	Dinex no.	Dinex no.	OD mm	OD Inch
L2000mm	L3000mm	L6000mm		
93738		93938	38,0	1 1/2
93745			45,0	1 3/4
93750	93952	93951	50,0	2
94754		93954	54,0	2 1/8
94757		93957	57,0	2 1/4
93361	93360	93960	60,0	2 3/8
93364	93363		63,5	2 1/2
93366	93365	93916	65,0	2 5/8
93371	93370	93970	70,0	2 3/4
94774			75,0	2 7/8
94775		93975	76,0	3
94780		93981	80,0	3 3/8
94790		93990	88,9	3 1/2
94700		94900	100,0	4
94703	93384	93903	101,6	4
94710		93911	110,0	4 1/4
94715			114,3	4 1/2
94720		93921	120,0	4 3/4
94727	93385	93928	127,0	5
94740			140,0	5 1/2
94750			150,0	5 7/8
93753		93953	152,4	6

MILD STEEL

Dinex no.	Dinex no.	Dinex no.	OD mm	OD Inch
L2000mm	L3000mm	L6000mm		
93332			32,0	1 1/4
93335			35,0	1 3/8
93338			38,0	1 1/2
93344			45,0	1 3/4
93348			48,0	1 7/8
93350			50,0	2
93354			54,0	2 1/8
93357			57,0	2 1/4
93358			60,0	2 3/8
93377		93976	76,2	3
93379			80,0	3 1/8
93383			83,0	3 1/4
93390	93389		88,9	3 1/2
93303	93302	93902	101,6	4
93309	93308	93908	108,0	4 1/4
93310	93311		110,0	4 5/16
93315	93314	93914	114,3	4 1/2
93352			152,4	6
93359			160,0	6 5/16

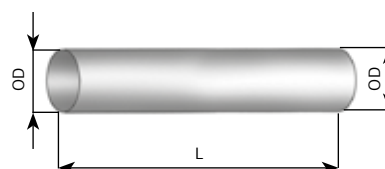

INOX

Dinex no.	Dinex no.	Dinex no.	OD mm	OD Inch
L1000mm	L2000mm	L2500mm		
93538			38,0	1 1/2
93550			50,0	2
93552	93551		51,0	2
	93560		60,0	2 3/8
93545	93566		63,0	2 1/2
	93576	93276	76,2	3
	93589		88,9	3 1/2
	93502		101,6	4
	93514		114,3	4 1/2
	93527		127,0	5

Material thickness 1,5 mm.

Extension Pipes

ALU

Dinex no.	Dinex no.	Dinex no.	Dinex no.	ID mm	OD mm	OD Inch
L600mm	L1000mm	L1500mm	L2500mm			
93651	93051	93151		51,3	50,0	2
93657	93057	93157		57,6	60,0	2 1/4
93660	93060	93160		60,5	60,0	2 3/8
93664	93064	93164		64,0	63,5	2 1/2
93670	93070	93170		70,3	69,8	2 3/4
93676	93076	93176		76,7	76,2	3
93689	93089	93189		89,4	88,9	3 1/2
93602	93002	93102		102,1	101,6	4
93608	93008	93108		108,5	108,0	4 1/4
93610	93010	93110		111,0	110,0	4 3/8
93614	93014	93114		114,8	114,3	4 1/2
93620	93020	93120		121,0	120,0	4 3/4
93627	93027	93127	93228	128,0	127,0	5

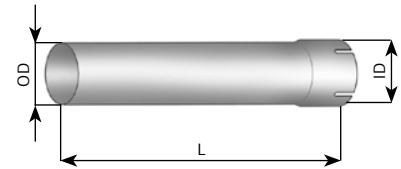

INOX

Dinex no.	Dinex no.	Dinex no.	ID mm	OD mm	OD Inch
L1000mm	L1500mm	L2500mm			
93564			64,0	63,5	2 1/2
	93577	93277	76,7	76,2	3
	93590		89,9	89,4	3 1/2
	93503		102,1	101,6	4
	93515		114,8	114,3	4 1/2
	93528		128,0	127,0	5

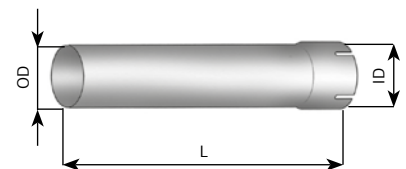

Material thickness 1,5 mm.

Tail Pipes

Tail Pipes OD

Dinex no.	Dinex no.	OD mm	OD Inch	L mm
ALU	INOX			
91477	91476	76,1	3	1000
	91489	89,0	3 1/2	1000
80714		88,9	3 1/2	1220
	91289	88,9	3 1/2	1500
	91402	101,6	4	1000
91403	91202	101,6	4	1500
91410		110,0	4 3/8	1000
80646		114,3	4 1/2	940
	91414	114,0	4 1/2	1000
80647		114,0	4 1/2	1450
	91214	114,3	4 1/2	1500
91428	91427	127,0	5	1000
91429	91426	127,0	5	1500
	91433	127,0	5	2000

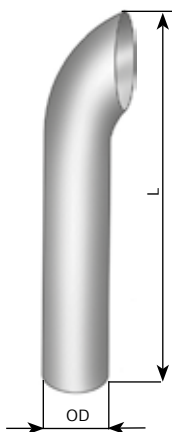

Dinex no.	OD mm	OD Inch	L mm
ALU			
85639	114,3	4 1/2	313

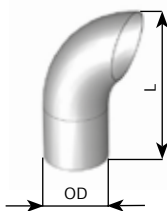

Tail Pipes ID

Dinex no.	Dinex no.	ID mm	ID Inch	L mm
ALU	INOX			
91450		50,5	2	260
91460		60,5	2 3/8	305
91465		65,5	2 5/8	1500
91470		70,5	2 3/4	300
91475		75,5	3	365
	91077	76,2	3	500
89699		76,0	3	1130
	91277	76,2	3	1500
	91377	77,0	3	2500
91480		80,5	3 1/8	340
	91090	90,2	3 1/2	500
	91390	89,5	3 1/2	2500
	91290	89,5	3 1/2	1500
91491		90,5	3 1/2	360
91401		101,0	3 7/8	375
	91003	102,0	4	500
	91203	102,0	4	1500
	91303	102,1	4	2500
91412		111,0	4 3/8	535
91411		111,0	4 3/8	1500
	91215	114,3	4 1/2	1500
80665		115,0	4 1/2	535
	91015	115,0	4 1/2	500
80661		115,0	4 1/2	1045
	91315	115,0	4 1/2	2500
91421		121,0	4 3/4	515
91420		121,0	4 3/4	1500
91431	91432	128,0	5	500
91430	91227	128,0	5	1500

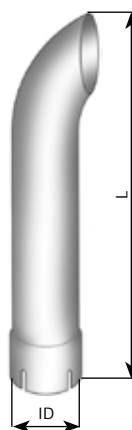

T & Y Adaptors, Connectors

Dinex no.	Dinex no.	OD mm	OD Inch
ALU	INOX		
91776		76,0	3
91789		89,0	3 1/2
91714	91715	114,3	4 1/2
91727		127,0	5

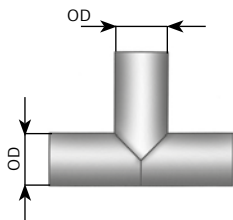

Dinex no.	OD mm	OD Inch
ALU		
18104	76,0	3
91490	89,0	3 1/2
91404	101,6	4

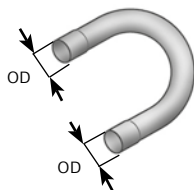

Dinex no.	OD mm	OD Inch
ALU		
92789	89,0	3 1/2
92702	102,0	4

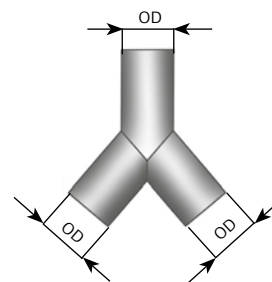

Dinex no.	ID/OD mm	ID/OD Inch
ALU		
68642	111,5/110,0	4 3/8-4 1/8

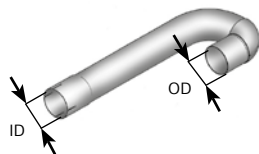

Dinex no.	OD mm	OD Inch	Design
INOX			
91814	114,3	4 1/2	T

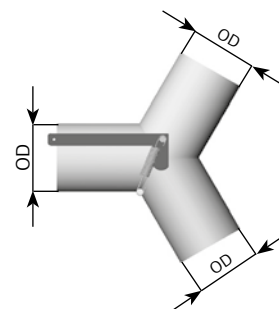
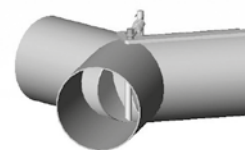

Pipe Adaptors

ID/ID

Dinex no.	ID1 mm	ID2 mm	ID1 Inch	ID2 Inch
ALU	INOX			
93751	51,0	60,5	2	2 3/8
93760	60,5	64,0	2 3/8	2 1/2
93761	60,5	70,5	2 3/8	2 3/4
93762	60,5	76,7	2 3/8	3
93764	64,5	70,8	2 1/2	2 3/4
93770	70,5	76,7	2 3/4	3
93774	75,5	90,5	3	3 1/2
93776	76,7	89,5	3	3 1/2
93777	76,7	103,0	3	4
93780	80,5	89,5	3 1/8	3 1/2
93772	80,5	102,1	3 1/8	4
93789	89,4	102,1	3 1/2	4
93791	89,4	108,5	3 1/2	4 1/4
93792	89,4	110,5	3 1/2	
93793	89,4	114,8	3 1/2	4 1/2
93794	90,5	114,8	3 1/2	4 1/2
93799	101,0	103,0	4	4
93700	101,0	114,8	4	4 1/2
93702	102,0	109,0	4	4 1/4
93704	102,1	110,5	4	
93713	102,1	114,8	4	4 1/2
93705	102,1	127,5	4	5
93708	108,5	114,8	4 1/4	4 1/2
93711	108,5	120,5	4 1/4	4 3/4
93712	108,5	127,5	4 1/4	5
93716	110,5	114,8	4 1/2	
93717	110,5	120,5	4 3/4	
93718	110,5	127,5	5	
93719	114,8	127,5	4 1/4	5
93720	120,5	127,5	4 3/4	5

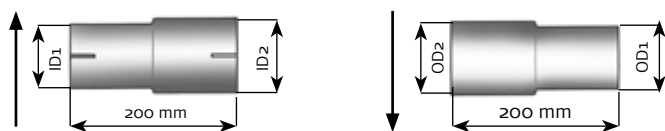

OD/OD

Dinex no.	OD1 mm	OD2 mm	OD1 Inch	OD2 Inch
ALU	INOX			
93795	54	57	2 1/8	2 1/4
93834	54	60	2 1/8	2 3/8
93830	60	62	2 3/8	2 3/8
93757	62	65	2 3/8	2 1/2

ID/OD

Dinex no.	Dinex no.	ID mm	OD mm	ID Inch	OD Inch
ALU	INOX				
	93754	38,0	50,0	1 1/2	2
	93766	50,0	63,5	2	2 1/2
93832		54,5	60,0	2 1/8	2 3/8
93798		54,5	61,5	2 1/8	2 3/8
93758		54,5	65,0	2 1/8	2 1/2
93835		54,5	60,0	2 1/4	2 3/8
93797		58	61,5	2 1/4	2 3/8
93796		60,5	61,5	2 3/8	2 3/8
93763		64,5	70,0	2 1/2	2 3/4
93769		70,8	76,2	2 3/4	3
93775		76,7	88,9	3	3 1/2
93785		77,0	102,0	3	4
93778		89,4	101,6	3 1/2	4
68125		89,5	110,0	3 1/2	4 3/8
93701		102,0	108,0	4	4 1/4
93714		102,1	114,3	4	4 1/2
93707		108,5	114,3	4 1/4	4 1/2
93225		103,0	127,0	4	5
93729		115,0	127,0	4 1/2	5

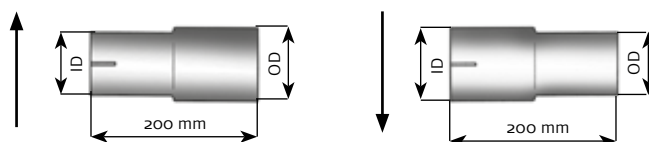

ID/OD

Dinex no.	Dinex no.	ID mm	OD mm	ID Inch	OD Inch
ALU	INOX				
	93755	50,0	38,0	2	1 1/2
93756		58,0	54,0	2 1/4	2 1/8
93800		61,0	57,5	2 3/8	2 1/4
	93767	63,5	50,0	2 1/2	2
93833		65,5	60,0	2 5/8	2 3/8
93782		77,0	76,0	3	3
93790		89,4	76,2	3 1/2	3
93787		90,0	89,0	3 7/8	3 1/2
93783		103,0	76,0	4	3
93721		103,0	102,0	4	4
93703		102,1	88,9	4	3 1/2
93710		110,5	101,6	4	3 1/3
93715		114,8	101,6	4 1/2	4
93722		128,0	102,0	5	4
93726		128,0	127,0	5	5

Material thickness 1,5 mm

Pipe Connectors

ID/ID

Dinex no.	ID mm	ID Inch	L mm
ALU			
93752	51,0	2	200
93759	61,0	2 3/8	200
93765	66,0	2 5/8	220
93771	71,0	2 3/4	210
93773	76,0	3	200
93781	76,5	3	200
93779	81,0	3 1/8	270
93788	90,0	3 1/2	250
93784	101,0	4	300
93706	103,0	4	200
93786	111,0	4 3/8	210
93725	115,0	4 1/2	300
93723	121,0	4 3/4	210
93724	128,0	5	205

Material thickness 1,5 mm

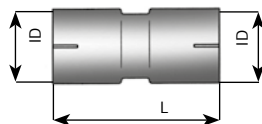

OD/OD

Dinex no.	OD mm	OD Inch
ALU		
93831	60	2 3/8
93801	62	2 3/8

Material thickness 1,5 mm

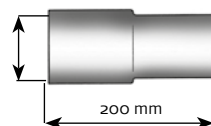

Insulation

Dinex no.	Layer	Dimensions
210085	Reflect Ins layer	50 mm/5,5 mm
210084	Reflect Ins layer	100 mm/5,5 mm
210086	Protective outer layer	80 mm/5,0 mm

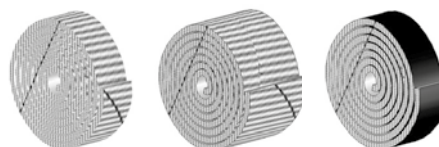

Flex Pipes

ZINC

Dinex no.	Dinex no.	OD mm	OD Inch	ID mm	ID Inch	Flex
L1000mm	L2000mm					
94125	94225	29,0	1 1/7	25,0	1	D2S
94128	94228	34,0	1 1/3	30,0	1 1/8	D2S
94132	94232	36,0	1 2/5	32,0	1 1/4	D2S
94135	94235	40,0	1 3/5	36,0	1 3/8	D2S
94138	94238	43,0	1 5/7	39,0	1 1/2	D2S
94141	94241	46,0	1 4/5	42,0	1 5/8	D2S
94144	94244	49,0	1 9/10	45,0	1 3/5	D2S
94148	94248	52,0	2	48,0	1 7/8	D2S
94151	94251	55,0	2 1/6	51,0	2	D2S
94154	94254	58,5	2 2/6	54,5	2 1/8	D2S
94157	94257	62,0	2 2/5	58,0	2 1/4	D2S
94160	94260	65,0	2 4/7	61,0	2 3/8	D2S
94164	94264	68,0	2 2/3	64,0	2 1/2	D2S
94165	94265	70,0	2 5/7	66,0	2 5/8	D2S+
94167	94267	71,0	2 4/5	67,0	2 5/8	D2S+
94170	94270	74,0	2 9/10	70,0	2 3/4	D2S
94176	94276	81,1	3 1/5	77,1	3	D2S
94180	94280	85,0	3 1/3	81,0	3 1/8	D2S+
94183	94283	87,0	3 2/5	83,0	3 1/4	D2S
94185	94285	90,0	3 1/2	86,0	3 2/5	D2S
94189	94289	92,9	3 5/7	88,9	3 1/2	D2S
94192	94292	97,0	3 4/5	93,0	3 5/8	D2S+
94195	94295	99,0	3 8/9	95,0	3 3/4	D2S
94100	94200	105,0	4 1/8	101,0	3 7/8	D2S+
94102	94202	106,7	4 1/5	102,7	4	D2S+
94108	94208	112,0	4 2/5	108,0	4 1/4	D2S+
94110	94210	114,0	4 1/2	110,0	4 3/8	D2S
94114	94214	119,5	4 5/7	115,5	4 1/2	D2S+
94120	94220	125,2	4 9/10	121,2	4 3/4	D2S
94126	94226	130,5	5 1/8	126,5	5	D2S+
94127	94227	132,3	5 1/5	128,3	5	D2S
94131	94231	135,5	5 1/3	131,5	5 1/3	D2S+
94140	94240	145,0	5 3/4	141,0	5 1/2	D2S+
94152	94252	157,5	6 1/5	153,5	6	D2S+

Max temperature 550 degrees - corrosion can occur at high temperatures.

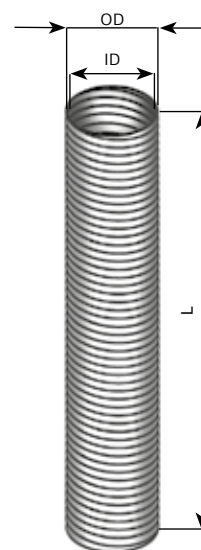

L - compressed length



Flex Pipes

INOX

Dinex no.	Dinex no.	OD mm	OD Inch	ID mm	ID Inch	Flex
L1000mm	L2000mm					
95125	95225	29,0	1 1/7	25,0	1	D2S
95132	95232	36,0	1 2/5	32,0	1 1/4	D2S
95138	95238	43,0	1 5/7	39,0	1 1/2	D2S
95141	95241	46,0	1 4/5	42,0	1 5/8	D2S
95144	95244	49,0	1 9/10	45,0	1 3/4	D2S
95151	95251	55,0	2 1/6	51,0	2	D2S
95154	95254	58,0	2 1/4	54,0	2 1/8	D2S
95157	95257	62,0	2 2/5	58,0	2 1/4	D2S
95160	95260	65,0	2 1/2	61,0	2 3/8	D2S
95164	95264	68,0	2 1/6	64,0	2 1/2	D2S
95165	95265	70,0	2 5/7	66,0	2 5/8	D2S
95170	95270	74,0	2 9/10	70,0	2 3/4	D2S
95176	95276	81,1	3 1/5	77,1	3	D2S+
95180	95280	85,0	3 1/3	81,0	3 1/8	D2S+
95185	95285	90,0	3 1/2	86,0	3 2/5	D2S
95189	95289	92,9	3 5/7	88,9	3 1/2	D2S+
	95217	93,9	3 5/7	89,9	3 1/2	D3S
95100	95200	105,0	4 1/8	101,0	3 7/8	D2S+
95102	95202	106,7	4 1/5	102,7	4	D2S+
	95218	106,7	4 1/2	102,7	4	D3S
95108	95208	112,0	4 2/5	108,0	4 1/4	D2S
95110	95210	114,0	4 1/2	110,0	4 3/8	D2S+
95114	95214	119,5	4 5/7	115,5	4 1/2	D2S+
95120	95220	125,2	4 9/10	121,2	4 3/4	D2S+
95126	95226	130,5	5 1/8	126,5	5	D2S
95127	95227	132,3	5 1/5	128,3	5	D2S+
	95219	132,3	5 1/5	128,3	5	D3S
95131	95231	135,5	5 1/3	131,5	5 1/8	D2S
95140	95240	144,0	5 2/3	140,0	5 1/2	D2S+
95153	95253	157,5	6 1/5	153,5	6	D2S+

Max temperature 550 degrees.

INOX - Convolute Flex

Dinex no.	L mm	OD mm	OD Inch	ID mm	ID Inch
95191	1000	103,0	4	77,0	3
95192	1000	115,0	4 1/2	90,0	3 1/2
95193	1000	12,08	5	103,0	4

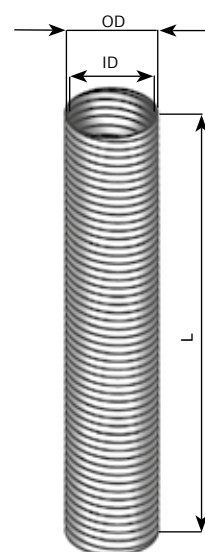

L - compressed length

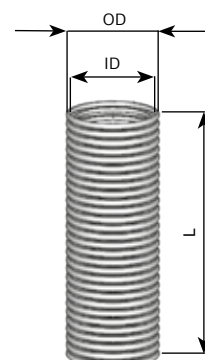
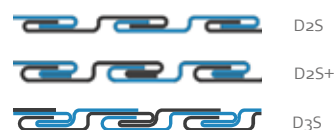

Flex Pipes

INOX (L<1000 mm)

Dinex no.	L mm	OD mm	ID mm	ID Inch	Flex
87151	410	55,0	51,0	2	D2S
87139	450	65,0	61,0	2 3/8	D2S
87164	450	68,0	64,0	2 1/2	D2S
50163	250	74,0	70,0	2 3/4	D2S
28270	224	81,0	77,0	3	D2S+
80220	326	81,0	77,0	3	D2S+
87176	450	81,0	77,0	3	D2S
95124	195	94,0	90,0	3 1/2	D2S
80641	210	94,0	90,0	3 1/2	D2S+
80513	258	94,0	90,0	3 1/2	D2S+
80157	365	94,0	90,0	3 1/2	D2S+
80155	392	94,0	90,0	3 1/2	D2S+
87189	450	94,0	90,0	3 1/2	D2S
49176	285	105,0	101,0	3 7/8	D2S
49199	375	105,0	101,0	3 7/8	D2S
82133	334	106,7	102,7	4	D2S+
81128	238	107,0	103,0	4	D2S+
64220	258	107,0	103,0	4	D2S+
87102	420	107,0	103,0	4	D2S+
80183	542	107,0	103,0	4	D2S+
94500	513	107,0	103,0	4	D2S+
49133	315	115,0	111,0	4 3/8	D2S+
68217	262	119,0	115,0	4 1/2	D2S+
81224	306	119,0	115,0	4 1/2	D2S+
81191	296	119,0	115,0	4 1/2	D2S+
80131	373	119,0	115,0	4 1/2	D2S+
95194	440	119,0	115,0	4 1/2	D2S
87114	450	119,0	115,0	4 1/2	D2S
80655	500	119,0	115,0	4 1/2	D2S
82187	233	119,5	115,9	4 1/2	D2S+
49247	382	125,5	121,5	4 3/4	D2S+
81728	124	132,3	128,3	5 1/16	D2S+
82140	295	132,3	128,3	5 1/16	D2S+
94501	513	132,0	128,0	5	D2S+

Max temperature 550 degrees.

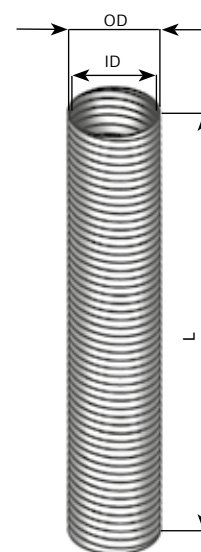

L - compressed length



Flex Pipes

Flex Pipes with Joints

Dinex no.	A-end	B-end	L mm	Flex
	Type	Type		
	Ø mm	Ø mm		
53162	Plain	Slitted	365	D2S+
51290	Plain	Slitted	365	D2S+
52176	Slitted	Slitted	365	D2S+
47194	Plain	Flex	415	D2S+
47183	Plain	Flex	375	D2S+

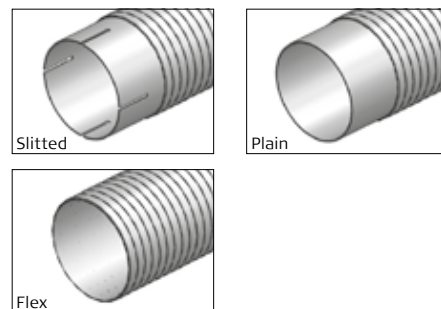

Bellows

With Exterior Steel Braid

Dinex no.	L mm	ID/OD mm	C mm	D mm
INOX				
95351	150	ID 51,0	100	25
95350	275	OD 51,5	215	30
95361	250	ID 60,5	200	25
95362	150	ID 60,0	100	25
95364	250	ID 64,5	200	25
95376	385	ID 76,0	275	50
95375	250	ID 76,5	200	25
95389	385	ID 90,0	300	50
95301	385	ID 103,0	285	50
95315	385	ID 115,0	285	50

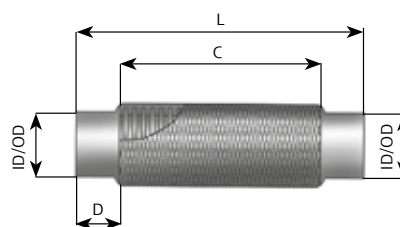

With Steel Braid & Inner Flex Layer

Dinex no.	L mm	ID/OD mm	C mm	D mm
INOX				
95352	100	ID 51,0	50	25
95353	150	ID 51,0	100	25
95354	205	ID 54,0	155	25
95363	200	ID 60,5	150	25
95334	152	ID 76,2	102	25
95335	203	ID 76,2	153	25
95336	254	ID 76,2	204	25

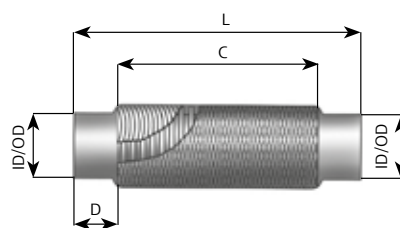

Bellows

Additional Bellow Types

Dinex no.	L mm	ID/OD mm	C mm	D mm
INOX				
95360	240	ID 61,0	120	60
95370	180	ID 71,0	110	35
95302	179	OD 102,0	103	38
95314	215	OD 114,3	95	60

Dinex no.	L mm	ID mm	C mm	D mm
INOX				
95390	380	90,0	188	60

Dinex no.	L mm	OD mm	C mm	D mm
INOX				
87141	160	102,0	81	42

Dinex no.	L mm	ID mm	C mm	D mm
INOX				
95304	240	61,0	203	37
95310	295	89,0	251	22

Dinex no.	L mm	ID mm	C mm	D mm
INOX				
95311	308	110,0	268	20
95337	225	85,2	180	

Dinex no.	L mm	ID mm	C mm
INOX			
95313	298	111,0	288

Dinex no.	L mm	ID mm
INOX		
95312	88	103,0

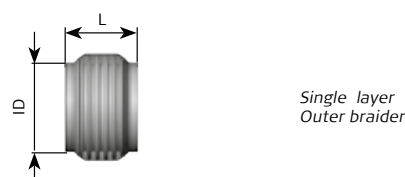
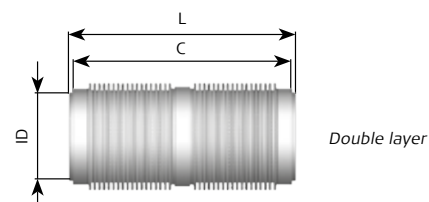
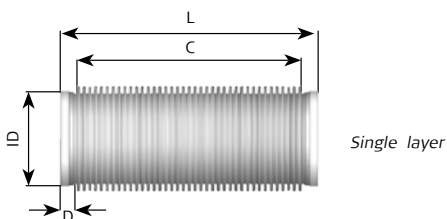
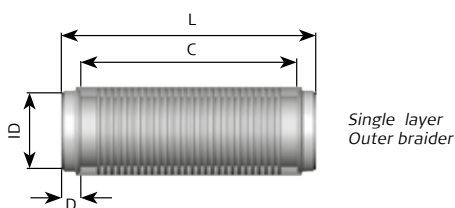
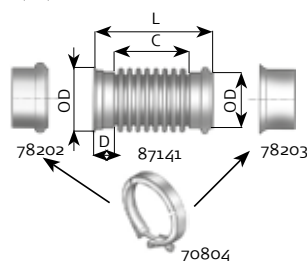
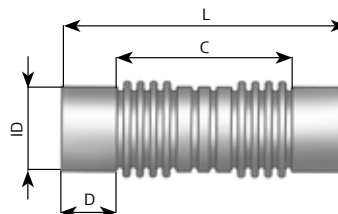
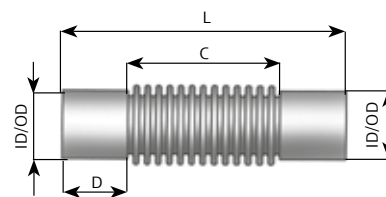

Rain Caps

Dinex no.	Dinex no.	Ø mm	Ø Inch
ZINC	INOX		
98450	98550	50,5	2
98460	98560	60,5	2 3/8
98464	98564	63,5	2 1/2
98470	98570	70,5	2 3/4
98476	98576	76,5	3
98480	98580	80,5	3 1/8
98489	98589	90,0	3 1/2
98400	98500	100,5	3 7/8
98402	98602	102,0	4
98410	98608	110,5	4 3/8
98414	98614	115,0	4 1/2
98420	98620	120,5	4 3/4
98427	98627	127,5	5
98451	98651	152,0	6



Dinex no.	Ø mm	Ø Inch
ZINC		
98445	45,0	1 3/4
98452	50,0	2
98455	55,0	2 1/8
98461	60,0	2 3/8
98465	65,0	2 5/8
98471	70,0	2 7/8
98475	75,0	3
98481	80,0	3 1/8
98491	90,0	3 1/2
98401	100,0	3 7/8
98411	110,0	4 3/8
98415	115,0	4 1/2
98421	120,0	4 3/4
98430	130,0	5 1/8

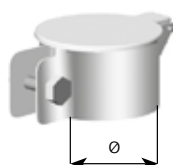

Flex pipe mounting instruction

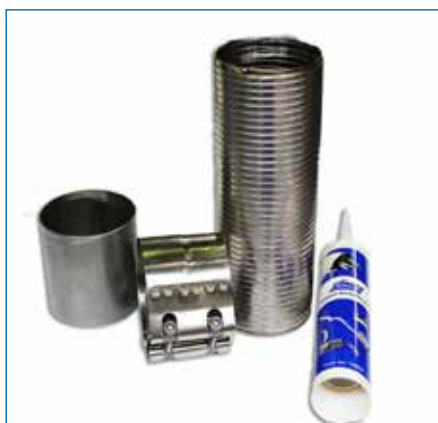

Recommendation. Use Dinex FlexFit clamps together with exhaust sealing past to minimize leakage of exhaust gas.



Please make spot welding after cutting the flex pipe to avoid the flex pipe loosening up.



Dinex FlexFit clamp with Exhaust Sealing Paste inside to minimize the leakage of exhaust gas.



The flex pipe must be in middle position for correct mounting.



The flex pipe should not be twisted or bent.



Temperature Sensors
For direct replacement of OE sensors

going the extra mile



Your Partner in Exhaust and Emission

DinSensor™, Temperature Sensors

Our Temperature Sensors are:

- Directly replaceable with OE Sensors
- Tested at Dinex Test Center
- Stock item for fast delivery
- Easy to install



Make	Truck	Bus	OE no.	Dinex no.
DAF	XF95, XF105, CF85, CF75		1810690, 1689811	22040
DAF	XF105, XF95		1810691, 1689812	22041
Iveco	Stralis		5801291814, 5801455941, 504109529	29042
Iveco	Stralis	Citelis, Airway, Crossway, Crealis, Minirider, Cityclass, Eurorider, Magelis, Domino	504102603, 5801455940, 55581035	29043
MAN	TGS, TGX, TGA, TGL, TGM		81.27421.0253, 81.27421.0264, 81.27421.0242, 81.27421.0237	47040
Mercedes-Benz	Actros, Axor, Antos		006.153.0628, 1614310103	51040
Mercedes-Benz	Actros		006.153.0728, 1614310104, 1614320014	51041
Mercedes-Benz	Actros, Axor		006.153.0528, 1614310102, 160310803048	51042
Scania	P,G,R,T	F,K,N	2265872, 2253825	67040
Volvo/Renault	FH, FM, FH(4), FM(4), T/K/C series	B13R, B7FB, B11R, B5LH, B8R, B8L	21412472, 7421412472	81043
Volvo/Renault	FH, FM, FH12, FM12, FE, FL, Kerax, Premium	B13R, B9L, B9S, B9TL, FE, FL, B5LH, B6R, B7R, B9R, B12B, B12M, B5RH	20889280, 20451990, 7420889280, 7420451990	81033
Volvo		B13R, B5LH, B8R	21164792	81044
Volvo/Renault	FH, FM, Kerax, Premium	B11R, B5LH, B8R, B8L	21225020, 7421225020	81045
Volvo	FH, FM	B11R, B5LH, B8R	21164414	81046
Volvo/Renault	FL, FE, Premium, Midlum	B8R, B5LH	21164790, 7421164790	81047



going the extra mile



Launch of new and reconditioned (RX) Euro 6 DPF Program

NEW		RECON		OE reference	Make	Truck	Bus	Release
Dinex	Dinex RX	Dinex	Dinex RX					
2AI000	2AI000-RX	2AI000	2AI000-RX	1891485, 1945456, 2137441R	DAF	XF/CF		Available
4II003	4II003-RX	4II003	4II003-RX	81.15103.0113	MAN	TGL, TGM		Available
8AI001	8AI001-RX	8AI001	8AI001-RX	21750157, 21794709, 85013698, 85020453, 23037748	Volvo	FE 3, FL 3	B8R 3, B5LH 3, B8L 3	Available
8AI001	8AI001-RX	8AI001	8AI001-RX	7421794709, 7421750157, 7485013250, 7423138863	Renault	D/C		Available
8AI002	8AI002-RX	8AI002	8AI002-RX	21716414, 21716416, 22936980, 23108407, 23135528, 23108408	Volvo	FH 4, FM 4	B11R 3	Available
8AI002	8AI002-RX	8AI002	8AI002-RX	7421716414, 7421716416, 7423135543, 7421716419	Renault	T/K/C		Available
8AI004	8AI004-RX	8AI004	8AI004-RX	21716417	Volvo	FH 4, FM 4		Available
8AI004	8AI004-RX	8AI004	8AI004-RX	7421716417	Renault	T/K/C		Available
1JI001	1JI001-RX	1JI001	1JI001-RX	662569-2	ADL		Enviro 200	Available
1JI001	1JI001-RX	1JI001	1JI001-RX	1997433, 1997433R, 2137422	DAF	LF		Available
2AI003	2AI003-RX	2AI003	2AI003-RX	1961522, 1961522R	DAF	LF		Available
2AI003	2AI003-RX	2AI003	2AI003-RX	2274555	Scania		F, N, K	Available
5AI001	5AI001-RX	5AI001	5AI001-RX	001.490.3092	Mercedes	Atego, Actros		Available
5AI004	5AI004-RX	5AI004	5AI004-RX	001.490.2992, 001.490.3692, 001.490.3892	Mercedes	Actros		Available
5AI005	5AI005-RX	5AI005	5AI005-RX	001.490.5292, 001.490.5392, 001.490.7092, 001.490.8392, 001.490.8492, 001.490.8592, 001.490.8692	Mercedes	Actros, Antos		Available
5AI007	5AI007-RX	5AI007	5AI007-RX	001.490.2892, 001.490.2792, 002.490.3892, 002.490.3992, 000.490.5892	Mercedes	Antos/Arocs		Available
5AI009	5AI009-RX	5AI009	5AI009-RX	001.490.4892	Mercedes	Actros/Arocs		Available
5AI010	5AI010-RX	5AI010	5AI010-RX	001.490.6492	Mercedes	Actros		Available
5AI012	5AI012-RX	5AI012	5AI012-RX	002.490.4292, 002.490.2892	Mercedes	Actros/Arocs		Available
5AI013	5AI013-RX	5AI013	5AI013-RX	001.490.6292	Mercedes	Atego		Available
5AI015	5AI015-RX	5AI015	5AI015-RX	001.490.3792	Mercedes	Atego		Available
2KI000	2KI000-RX	2KI000	2KI000-RX	5801651186, 5802039934	Iveco	Stralis, Trakker		Mid Q1/21
2KI002	2KI002-RX	2KI002	2KI002-RX	5801651187, 5802039929	Iveco	Stralis, Trakker		Mid Q1/21
2KI010	2KI010-RX	2KI010	2KI010-RX	5801651188, 5802039924	Iveco	Stralis, Trakker		Mid Q1/21
2KI014	2KI014-RX	2KI014	2KI014-RX	5801651207, 5802045132	Iveco	Eurocargo		Mid Q1/21
2KI015	2KI015-RX	2KI015	2KI015-RX	5801651208, 5802045133	Iveco	Eurocargo		Mid Q1/21
4II001	4II001-RX	4II001	4II001-RX	81.15103.0107, 81.15103.9107	MAN	TGX, TGS		Mid Q1/21
6LI000	6LI000-RX	6LI000	6LI000-RX	570759, 2097594, 2269640, 2575576, 2179961	Scania	P, G, R, T	F, N, K	Mid Q1/21
6LI001	6LI001-RX	6LI001	6LI001-RX	570758, 2137598, 2222655, 2446964	Scania	P, G, R, T		Mid Q1/21



All Dinex new and reconditioned DPFs include clamps and gaskets



On Recon RX DPF filters



On New DPF filters



NOx Sensors
For direct replacement
of OE sensors

going the extra mile



Your Partner in Exhaust and Emission

DinSensor™, NOx Sensors

Our NOx Sensors are:

- Directly replaceable with OE Sensors
- Tested at Dinex Test Center
- Tested and accredited by third party
- A cost effective balance between emission control and Urea consumption
- Stock item for fast delivery
- Easy to install



Make	Truck	Bus	LCV	Norm	OE no.	Continental ref. no.	Dinex no.
DAF	XF / CF			Euro 6	2236408	-	22026
DAF	XF / CF			Euro 6	2236406	-	22027
DAF	LF / XF			Euro 6	1710806, 4326864	5WK96750C	22028
DAF	XF 105, CF 75, CF 85	BOVA, Solaris		Euro 5	1836059, 1793378, 1744683, 2011648,	5WK96619B, 5WK96619D	22030
DAF	XF 105, CF 75, CF 85, XF 95			Euro 5	1697586, 1836060, 1793379, 2011649	5WK96628A, 5WK96628C	22032
DAF	LF 45, LF 55, CF 65			Euro 5	1705572, 1705520, 1703687, 1702178, 2894940	5WK96675A	22033
DAF	XF			Euro 6	2006243, 1936256, 1973525	5WK97344B	22034
DAF	XF			Euro 6	1928760, 1953530, 4326868	5WK96752C	22035
DAF	XF			Euro 5	1746581, 1793380, 1836061, 2011650	5WK96626C	22036
DAF	CF / XF			Euro 6	2006245, 1973527, 1936258, 1932603, 1904788	5WK96661D	22037

Make	Truck	Bus	LCV	Norm	OE no.	Continental ref. no.	Dinex no.
DAF	XF			Euro 6	1952565, 4326862, 4326470	5WK965751C	22038
Iveco	EuroCargo, Tector, Stralis, Trakker			Euro 5	41271167, 5801754015, 5801424181, 5801273980, 5801754016, 5801443021, 42558451	5WK96615E, 5WK96615F, 5WK96615C, 5WK96733B, 5WK96733A	29030
Iveco	Stralis, Trakker			Euro 6	5801777219, 5801627702, 5801429373	5WK96720A, 5WK96720	29031
Iveco	EuroCargo, Stralis			Euro 6	5801754014, 5801627703	5WK96775A	29032
MAN	TGX, TGS, TGA	Lions City, Jetliner, Lions Regio		Euro 5	81.15408.0000, 81.15408.0004, 51.15408.0009, 51.15408.0015, 51.15408.0000, 51.15408.0004	5WK96618C, 5WK96618D	47030
MAN		Lions City, Jetliner, Lions Regio, UEL INTERCITY		Euro 5	51.15408.0008, 51.15408.0017	5WK96722B, 5WK96722	47031
MAN		Neoplan		Euro 5	51.15408.0019, 51.15408.0012	5WK96790B, 5WK96790	47032
MAN	TGM / TGL	Lion's city, Skyliner, Starliner, Cityliner, Tourliner, Lion's coach, Lion's regio, Intercity		Euro 6	51.15408.0007, 51.15408.0003, 51.15408.0016	5WK96721A, 5WK96721B	47034
MAN	TGX, TGS, TGL, TGM			Euro 6	51.15408.0011, 51.15408.0018	5WK96783B, 5WK96783	4IL018
Mercedes-Benz	Actros, Atego, Econic			Euro 6	010.153.1628	5WK97331A	51026
Mercedes-Benz	Actros, Axor			Euro 6	009.153.0128, 010.153.9628	5WK96659C, 5WK96659B	51027
Mercedes-Benz	Atego, Actros, Tourismo, Citaro, Capacity, Connecto, Integro, Intouro			Euro 6	010.153.1528	5WK97330A	51028
Mercedes-Benz	Actros, Atego			Euro 6	010.153.1728	5WK97332A	51029
Mercedes-Benz	Actros, Atego	Tourino, Citaro, Conecto, Travego, Tourismo, Intouro, Integro	Vario	Euro 5	006.153.7328, 009.153.3628, 009.153.7328	5WK96616F, 5WK96616E, 5WK96616D	51030
Mercedes-Benz	Actros, Axor			Euro 5	010.153.9328, 008.153.9828	5WK96642, 5WK96642A, 5WK96642B	51031
Mercedes-Benz	Actros, Axor			Euro 6	009.153.0028, 010.153.9528, 009.153.9528, 011.153.7328	5WK96653B, 5WK96653	51032
Mercedes-Benz			Sprinter	Euro 6	000.905.3403, 000.905.5100, 000.905.6900	5WK96681C	51033
Mercedes-Benz	Actros, Citaro, Connecto, Tourismo, Integro			Euro 6	008.153.9928, 010.153.9428	5WK96652B, 5WK96652A	51035
Mercedes-Benz	Atego, Actros, Econic, Tourismo, Integro, Travego			Euro 6	010.153.1428	5WK97329A	51036
Renault	Kerax, Midlum, Premium, Magnum			Euro 5	7422219283, 7422315990, 7422827993, 7421984358, 7485133215	5WK97371, 5WK96664E, 5WK96605C, 5WK96717B, 5WK96717A	81030
Renault	T, K, C, D			Euro 6	7422827991, 7422315988, 7422219281, 7421531797	5WK97368	81032
Scania	P, G, R, T, S	F, K, N		Euro 6	2247380, 2296800, 2294290, 2064768	5WK97400	67031
Scania	P, G, R			Euro 6	2247381, 2296801, 2294291, 2064769, 2064767	5WK97401	67032
Scania	P, G, R, T			Euro 5	2296798, 2247378	5WK96679C	67033
Scania	P, G, R, T, S	F, K, N		Euro 5	1782596, 1908536, 2020691, 2296799, 2247379, 1872080, 1732461	5WK96612F, 5WK96612D, 5WK96612B	67034
VDL		VDL buses		Euro 5	30206989, 41697586, 41793379, 30054236	5WK96628A, 5WK96628C	22032
VDL		VDL buses, Ambassador		Euro 5	30204038, 41793380, 30054237	5WK96626C	22036
Volvo	FL, FE, FH, FM	B5LH, B9L, B9S, B9TL, R9TL, B6R, B7R, B9R, B12B, B12M, B11R, B13R		Euro 5	21567736, 21984358, 22219283, 21473997, 22315990, 22827993, 21244501, 20873117, 20873395, 21531794, 21387788, 20751663	5WK97371, 5WK96664E, 5WK96605C, 5WK96717B, 5WK96717A	81030
Volvo	FL, FE, FH, FM, B12M, B5LH, B9L, B6R, B7R, B5RH			Euro 6	22219284, 22315987, 22827995, 21691455, 21567742, 21474017, 21326719	5WK97372	81031
Volvo	FH(4)/FM(4), FL(3) FE(3), FH/FM	B5LH, B8R		Euro 6	22827991, 21567737, 21531797, 21474015, 22219281, 22315988, 21040930	5WK97368	81032

Contact your local Dinex office or visit dinex.net for more information.

Make contact

We are ready to serve you – please contact us!

Sales & Distribution

Denmark Dinex A/S

Fynsvej 39
DK-5500 Middelfart
Tel +45 63 41 25 00
Fax +45 63 41 25 25
dinex@dinex.dk

France Dinex France S.A.S.

6, rue des Malines
F-91090 Lisses
Tel +33 1 69 11 88 00
Fax +33 1 69 11 88 01
dinex@dinex.fr

Italy Dinex Italia S.r.l.

Zona Art.-Industriale
IT-64021 Colleranesco
Giulianova (TE)
Tel +39 085 8028693
Fax +39 085 8028692
dinex@dinex.it

Spain Dinex Ibérica Sistemas de Escape S.L.

Ctra. de Torrelles, Nave 42
E-08620 Sant Vicenc, Dels Horts
Barcelona
Tel +34 93 656 81 40
Fax +34 93 656 01 00
dinex@dinexescape.es

Serbia Dinex Balkan D.O.O.

Ive Lole Ribara 65
21203 Veternik
Tel +381 21 310 10 26
dinex@dinex.rs

Germany Dinex Deutschland GmbH

Adam-Stegerwald-Str. 21
67454 Haßloch
Tel +49 180 225 1125
Fax +49 6655 918601
bestellung@dinex.de

Poland Dinex Polska Sp. z o.o.

ul. Starowiejska 11
PL-80-180 Kowale k/Gdanska
Tel +48 58 712 66 55
Fax +48 58 712 66 65
dinex@dinex.pl

United Kingdom Dinex Exhausts Ltd.

14 Chesford Grange
Woolston, Warrington
Cheshire WA1 4RE, UK
Tel +44 1925 849 849
Fax +44 1925 849 850
dinex@dinex.co.uk

Production, Sales & Distribution

Latvia Dinex Latvia SIA

Rubeņu ceļš 58, Raubēni
Ozolnieku nov. LV-3002
Tel +371 63020200
Fax +371 63020059
dinex@dinex.lv

Turkey Dinex Egzoz ve Emisyon Teknolojileri San. ve Tic. AŞ

Yıldırım Beyazıt Mah.
Bayrak Sok. No:16/1
TR-59500 Cerkezköy/Tekirdag
Tel +90 282 736 4040
Fax +90 282 727 4040
dinex@dinex.com.tr

USA Dinex Emission Inc.

2020 Waldrep Industrial Blvd.
Dublin, GA 31021, USA
Tel +1 478 272 2466
Fax +1 478 272 2491
dinex@dinexemission.com

Russia Dinex RUS LLC

188300 Russian Federation
LO, Gatchinskiy district
Gatchina city, ul Industrialnaya, d. 20B
Tel.: +78 126 104 007
Fax: +78 137 191 855
dinex@dinex.net

Finland Dinex Finland OY

P.O. Box 20 (Vihtavuorentie 162)
FIN-41331 Vihtavuori,
Tel +358 10 65351
Fax +358 62 350000
info@dinex.fi

China Dinex Emission System Co., Ltd.

Building 9, No.2, Teng Long Road
Wujin Economic Zone,
Changzhou Jiangsu Province, CN
Tel +86 0519 8129 1586
Fax +86 0519 8129 2586
dinex@dinex.cn



Head Office
Denmark
Dinex A/S
Fynsvej 39
DK-5500 Middelfart
Tel +45 63 41 25 00
Fax +45 63 41 25 25
dinex@dinex.dk



Huzells

KARLSTAD
BLEKEGATAN 9
652 21 KARLSTAD
054-85 22 00



**TUNGA DELAR
SVERIGE AB**

GÄVLE
UTMARKSVÄGEN 4
802 91 GÄVLE
026-17 17 60